

# Ken-Tool®

**WHEREVER TIRES ARE CHANGED™**

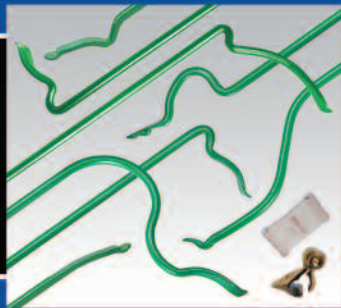

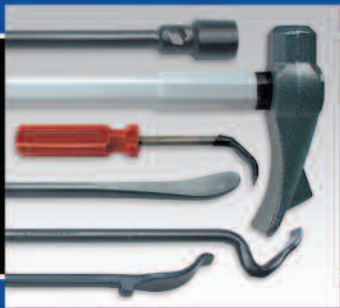

### *About Ken-Tool*

Ken-Tool is the leading manufacturer of tire service tools in the world. Headquartered in Akron, Ohio, Ken-Tool has been providing the tire industry and automotive aftermarket with quality products for nearly 90 years.

A lot of change has occurred within Ken-Tool over the years. But its long-time slogan, "Wherever Tires Are Changed", has held true. Ken-Tool's brand name and reputation remain the best in the tire-service industry, and it is the passion of the company's leaders to make sure that continues to be true in the years ahead.

Housed in a 70,000 square foot facility, Ken-Tool is a primary manufacturer of hand-tool products, with its manufacturing expertise centered on drop hammer, up-setter and press forgings. The company goes to market through the traditional aftermarket distribution network.



Throughout this catalog watch for YouTube symbols that indicate one or more videos are available for the product you are reviewing. Then go to [www.youtube.com/kentoolvideomedia](http://www.youtube.com/kentoolvideomedia) to find a selection of videos for our products. You can also scan the barcode with your Smartphone to get a link to our YouTube videos or details on how to Contact Us at Ken-Tool.



768 E. North St., Akron, Ohio 44305

Phone: 330-535-7177 • Fax: 330-535-1345

Visit our web site at: [www.kentool.com](http://www.kentool.com)

## New Products

Blue Cobra™	4
Valve Breaker™	5
Tire Mount/Demount Lubricant	8
Nineteen-Five™ Tire Mount/Demount Tool Set	6
Bead Holder for 19.5" Aluminum Wheels	6
Iron-Man™	7
Heavy-Duty Double-End Spoons	10, 11
Specialty Sockets, Torque Sticks & Extensions	12, 13, 14, 15
Universal Master TPMS Sensor Hardware & Tool Service Set	16
TPMS Sentry™	16
Aluminum Bead Holders	9
Polymer Coated Steel Bead Holders	9
Easy-Lift™ Bead Seating Stand	18
Industrial Lock-Ring Tools	19
Tire & Wheel Service Center	20, 21
Impact Separator Tool	43

## Hard Cap® Chisels & Punches

Chisels	44, 45
Punches	44, 44
Chisel & Punch Sets	45

## Pro Super Hub-Shark® (7326)

Pro Workshop Vises	22, 23
Pro Reversible Mechanic's Vises	22, 23
Professional C-Clamps	23

## Serpent™ Tire Changing Sets

Serpent™ Mount & Demount Tools	24, 25
Super Serpent™ Mount & Demount Tools	26, 27

## Ken-Tool®

<b>A</b>	
Aligning Bars	42
Aluminum Wheel Protector	4, 6, 25, 27, 36
<b>B</b>	
Ball Joint Separator	43
Bead Breakers	
ATV	40
Driving Iron	33
Floor Type	33
Impact	33
Portable	32
Truck/Farm/OTR	32
Wedges	38
Bead Expanders, Pneumatic	41
Bead Holders	
Aluminum Bead Holders	9
Bead Holder for 19.5" Aluminum Wheels	6, 9
Brass Bead Holding Device	6, 9, 25, 27, 36
Polymer Coated Steel Bead Holders	9
Bead Seaters	40, 41
<b>C</b>	
Center Cap Removers	
Wide Blade	31
Narrow Blade	31
Chrome Lug Nut Cover Remover	41
<b>D</b>	
Dual Wheel Stud Remover	30
<b>F</b>	
Front End Tools	
Ball Joint Separator	43
Pitman Arm Wedge	43
Separator Tool	43
Shock Link/Tie Rod Separator	43
<b>H</b>	
Hammers	
Cross-Pein/Blacksmith	38
Dead Blow	38
Epoxy Kits	39
General Purpose	39
Heavy-Duty	39
New England Hand Drilling	38
Replacement Rubber Heads	39
Rubber Mallet	38
Sledge	38

Handles	
Aluminum, Fiberglass, Wood	39
<b>L</b>	
Leak Locator	8
Leverage Bar	29, 32
Lock Ring Tools	19, 33, 34
Tire & Bead Lubricant	8
<b>M</b>	
Manual Tire Changers for Small Tires	40
<b>P</b>	
Pitman Arm Wedge	43
<b>R</b>	
Rim Guard	14, 30
<b>S</b>	
Separator Tool	43
Shock Link/Tie Rod Separator	43
Sockets	
Flip Sockets	14, 15, 41
Heavy-Duty Impact	14, 15, 41
Socket Sets	14, 15
Twist Sockets	14, 15
Spring Compressor, McPherson Strut	43
Swab, Bead Lubricant	8
<b>T</b>	
Tire Tool & Lug Wrench Merchandisers	20, 21
Tire Changing Stand	37
Tire Inflation Cages	37
Tire Irons (Mount/Demount)	
European Style	35
Heavy-Duty Truck	35, 36
Motorcycle/Small Wheel	34
Nineteen-Five™ Tire Mount/Demount Set	6
Tire Snakes®	40
Tubeless	35, 36
Tire Knockers	38
Tire Spoons	
Curved	10, 11, 35
Curved w/Flat Tip	10, 11
Drop-Center	10, 11, 35
Straight	10, 11, 35
Double-End Spoons	10, 11
Tire Spreaders	42
Torque Master Torque Sticks & Extensions	12, 13
Truck Wrench Handle	
Leverage Bar	29
<b>V</b>	
Valve Repair Tools	43
<b>W</b>	
Wedges	
Bead Breaking	38
Wheel Balancer	42
Wheel Cover Puller/Replacer	31
Wheel Lock Remover	41
Wheel Lock Remover Kit	13
Wheel Weight Tools	42
Wire Brush	42
Wrenches	
4-Way Lug Wrenches	
Folding	29
Heavy-Duty Truck	28
Light Truck/SUV	28, 29
OTR	28
Passenger Car	28, 29
Telescoping	29
Cap Nut	
Combination	31
Heavy-Duty	31
Ken-Tool Porkchop™	31
Double-End Truck	29
Power Wrench	30
Wrench Support Stand	29

**NEW** Look for this symbol beside individual product listings for exciting new tools from Ken Tool. All weights and measures are nominal. Variations in manufacture may occur.

**NEW**

**Ken-Tool®**

WHEREVER TIRES ARE CHANGED™

# BLUE COBRA™

## TRUCK TIRE DEMOUNT TOOL

Introducing an affordable alternative!



*Demounts truck tires in seconds!*



**WATCH OUR VIDEO ON  
[www.kentool.com](http://www.kentool.com)  
TO SEE 4 TRUCK TIRES  
DEMOUNTED IN ABOUT A MINUTE!**



- **Tougher build**
- **Better price**

*Fast and easy, the Blue Cobra™ truck tire demounting tool is strong but economical - the new 'golden' standard for tire changing!*

- Quickly demount nearly any 22.5" and 24.5" tubeless truck tire, up to a 13" wide wheel
- Ergonomic shaped steel handle with no-slip grip for optimum leverage while reducing back injuries
- Solid steel Cobra head is press-fit into the steel handle — no fasteners to loosen or fall out
- Allows demounting of the tire without lifting the entire wheel and tire off the ground — reduces back injuries
- Made of durable high-quality steel—won't prematurely wear out like tools made of brass or bronze
- Aluminum bead support to grab the top bead of Super Single and Super Wide tires
- 2 heavy-duty nylon rollers are easily replaced when worn, kit No. 35441 includes two rollers and two roll pins

Part No. 35440



• **Special Bonus!** Ken-Tool's patented leather wheel protector No. 31810 included to help protect expensive alloy wheels!

- 54" long, 22 lbs., boxed and UPS shippable

KEN-TOOL • 768 E. North Street, Akron, OH 44305

Toll Free: 888-536-8665 • Fax: 800-872-4929 • Phone: 330-535-7177 • Fax: 330-535-1345

E-mail: [sales@kentool.com](mailto:sales@kentool.com) • [www.kentool.com](http://www.kentool.com)

KT080610

**NEW**

**Ken-Tool®**

WHEREVER TIRES ARE CHANGED™

# VALVE BREAKER™

Quickly & easily remove valve stems from wheels!

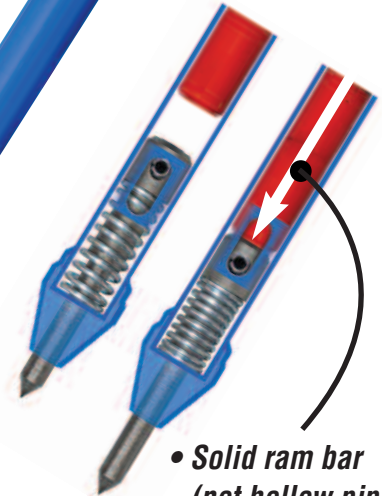

• Solid ram bar (not hollow pipe) drives more energy into valve



Part No.  
35934

Part No.  
35936



PATENT PENDING

## Compact and powerful!

- Made in USA from quality, high-grade steel
- Heat-treated punch for top performance and long life
- Pinch-preventing Safety Grip with vibration dampening tube grip
- Long-lasting baked powder coat finish
- T34B designed to fit into most 30" toolboxes
- Simple to re-build — only 3 components
- Available in two sizes:

Model No.	Item No	Description	Length	Weight
35934	T34B	Valve Breaker	27"	9 lbs
35936	T36B	Valve Breaker	45"	16 lbs



Repair Kit  
Part No. 35935

**NEW**

**Ken-Tool®**

WHEREVER TIRES ARE CHANGED™

# NINETEEN-FIVE™ TIRE MOUNTING & DEMOUNTING TOOL SET FOR 19.5" TRUCK TIRES

Everything you need to take the hassle out of changing 19.5" truck tires!

*19.5" tires must be mounted and demounted with the wheel's Hub Side Up because the Drop Center of the wheel is closer to the hub!*

*This makes changing the 19.5" tires notoriously difficult because the hub gets in the way of conventional bars and spoons. 19.5" tires are also stiffer with high ply ratings and thick beads. Nineteen-Five™ bars are specially designed to work on the hub side to make your job easier, faster and safer!*

- New tire bar uniquely designed to work on hub side of wheel — where hub protrudes above rim
- Specially designed ends manipulate tire with less effort
- Tools are powder coated to protect from rust and corrosion
- Forged from high-grade carbon steel and heat-treated for long-lasting strength and durability
- Specially designed Bead Holder to hold bead on 19.5" aluminum wheels
- Solid brass Bead Holder for steel wheels
- Aluminum Wheel Protector — thick leather pad helps protect rims from marring and scratching



Watch the Video Demo at [www.kentool.com](http://www.kentool.com)!

Part No. 33199  
Mounting/Demounting  
Tool

PATENTED



Part No. 31810  
Aluminum  
Wheel Protector



Part No. 33196  
Bead Holder for  
19.5" Aluminum  
Wheels

PATENTED



• Bent end  
For mounting and demounting  
bottom bead



Part No. 31710  
Bead Holder for  
Steel Wheels



• Curved end  
For mounting and demounting  
top bead

**Part No. 33195 NINETEEN-FIVE™  
Tire Mounting and Demounting Set  
Includes:**



Model No.	Set Qty.	Description	Length	Weight
33199	2	Tire Mounting/Demounting Tool	38"	7 lbs
33196	1	Bead Holder for 19.5" Aluminum Wheels	7-1/2"	1 lb
31710	1	Bead Holder for Steel Wheels - Solid Brass	4-1/2"	1 lb
31810	1	Aluminum Wheel Protector - Leather	6"	.35 lbs

KEN-TOOL • 768 E. North Street, Akron, OH 44305

Toll Free: 888-536-8665 • Fax: 800-872-4929 • Phone: 330-535-7177 • Fax: 330-535-1345

E-mail: [sales@kentool.com](mailto:sales@kentool.com) • [www.kentool.com](http://www.kentool.com)

KT111809

**NEW**

**Ken-Tool®**

WHEREVER TIRES ARE CHANGED™

**DON'T RISK INJURY**



# IRONMAN™ ERGONOMIC WHEEL LIFTING BAR

Reduces back strain & injury when lifting truck tire & wheel assemblies.

*Use the leverage created by the tool  
– NOT YOUR BACK!*

*Simple, inexpensive, easy-to-use tool substantially reduces the risk of back strain and injury.*

- Easily and safely lift heavy, awkward truck tire and wheel assemblies
- Extremely useful in outdoor conditions – when truck tire and wheel assemblies can become wet & slippery
- Protect your workers and yourself – reduce injuries & claims – keep insurance premiums down
- Specially designed forged ends work from either side of the wheel assembly as it lays flat
- Lift all sizes and types of small and large heavy truck wheels: Standard sizes including 22.5" and 24.5" wheels, plus European (which have 1" lug holes), Super Wide and even the Super Single (a 340 lb. assembly) size
- Length: 58" nominal • Weight: 10-lbs



Part No. T950 (34950)



- Specially designed knob end for hub side up



- Specially designed spoon end for hub side down



KEN-TOOL • 768 E. North Street, Akron, OH 44305

Toll Free: 888-536-8665 • Fax: 800-872-4929 • Phone: 330-535-7177 • Fax: 330-535-1345

E-mail: sales@kentool.com • www.kentool.com

KT030208

**NEW**

**Ken-Tool®**  
WHEREVER TIRES ARE CHANGED™

# TIRE MOUNT/DEMOUNT LUBRICANTS



Introducing our newest line-up!

*Professional grade lubricants make  
tire mounting and demounting easier and more efficient.*



**35837—Tiger Paste Lubricant**

Superior formulation for commercial, OTR and specialty equipment tires, with rust inhibitor. .... 7.5-lb bucket

**35839—Ultra Lube**

Premium rim and rust retardant and tire mounting lubricant for demanding applications ..... 25-lb pail

**35848—Euro Paste Lube**

Premium tire mounting lubricant dries tacky to prevent rim slippage, with rust retardant ..... 8-lb bucket

**35840—Heavy Paste Lube**

Concentrated economical tire mounting and bead packing lubricant, makes up to 15-gallons ..... 25-lb pail

**35847—Bead-Eze® Lube**

Penetrating water-based lubricant for tire mounting, can be diluted for leak detection, six-pack ..... 1-gal. 6-pack

**35847S—Bead-Eze® TIRE Lube**

Penetrating water-based lubricant for tire mounting, can be diluted for leak detection ..... 1-gal. single

**35805—Detecto Mist® Leak Locator**

Spray on tire to instantly detect air leaks, concentrated formula dilutes with water ..... 1-qt

**30511—Bead Lubricant Swab**

Durable cotton applicator quickly holds and applies lube, twisted wire construction and wood handle. .... 10" long

**KEN-TOOL • 768 E. North Street, Akron, OH 44305**

**Toll Free: 888-536-8665 • Fax: 800-872-4929 • Phone: 330-535-7177 • Fax: 330-535-1345**

**E-mail: sales@kentool.com • www.kentool.com**

KT081610



# BEAD HOLDERS

## ALUMINUM • COATED STEEL • BRASS

Keeps bead from slipping over rim when mounting tire on wheel!

*No more vise grips! No more ugly scratches!*  
*Ideal for stiff tires • Holds in place • Makes tire mounting easier, faster & safer*

### NEW Aluminum Bead Holder For Steel And Aluminum Wheels

- Special C-Lok™ shape fits nearly all passenger, light truck, agriculture and truck wheels without slipping off
- Patent pending aluminum design is lightweight but very strong and is less likely to mar alloy wheels
- Great for super singles and super wide wheels — fits both steel and aluminum wheels
- Available as a cabled pair No. 31714 for difficult wheels

Model No.	Description	Weight
31713	Single Aluminum Bead Holder	0.5 lb
31714	32" Cabled Pair	1 lb

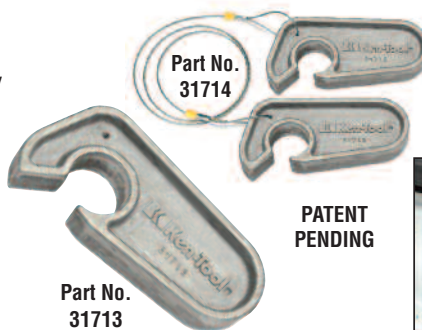

PATENT PENDING



### NEW Polymer Coated Steel Bead Holder For Steel And Aluminum Wheels

- Polymer coated steel bead holders to reduce slippage and damage to steel and aluminum truck wheels
- 1/2"-opening for steel wheels – yellow
- 5/8"-opening for aluminum wheels – blue

Model No.	Description	Weight
31711	Yellow Rubber Coated Bead Holder	1 lb
31712	Blue Rubber Coated Bead Holder	1 lb



Part No. 31711

Part No. 31712



### Bead Holder For 19.5" Aluminum Wheels

- Patented steel bead holder for 19.5" aluminum truck wheels that fit 9/16" diameter studs
- Always mount/demount 19.5" wheels with hub side up

Model No.	Description	Weight
33196	Bead Holder for 19.5" Aluminum Wheels	1 lb

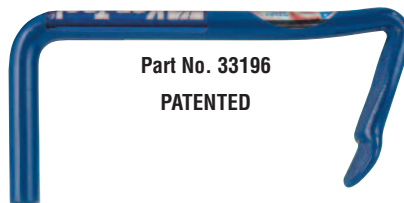

Part No. 33196  
PATENTED



### Brass Bead Holder

- Reliable brass design won't slip or mar expensive painted or alloy truck wheel

Model No.	Description	Weight
31710	Solid Brass Bead Holder	1.8 lbs



Part No. 31710

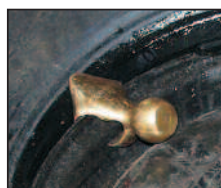

Watch our Product Demos on



**NEW**

**Ken-Tool®**

WHEREVER TIRES ARE CHANGED™

# HEAVY-DUTY DOUBLE-END SPOONS

New double-end spoons offer more versatility and greater leverage. Dozens of size and shape combinations to choose from!

- *Constructed of premium-quality carbon steel and heat-treated for long-lasting performance*
- *Designed for fast and efficient tire changing*
- *The highly versatile spoon often doubles as a mechanics helper wherever leverage is needed*

**Four popular end designs to choose from:**

### **Straight End Spoon**

*Used to mount and demount. Great for pushing straight into a tight-fitting bead for the first pull during demounting.*

### **Curved End Spoon**

*A general-purpose tool used to mount or demount. A preferred mounting tool with a curve that reaches under a stretched bead and over the rim for that last pull. It is sometimes used backwards to mount the first bead with less interference from the top bead.*

### **Drop-Center Spoon**

*A favorite to mount or demount. Great for "hooking" the rim to prevent the tool from popping out, as some tools will do, while mounting the first bead of a tough tire. Also great for hooking behind and under the bead during demounting.*

### **Curved End with Flat Tip Spoon**

*This new tool design will dig down under the bead for easy demounting. Also great for reaching under a stretched bead and over the rim for mounting without slipping out. The bead slips down the curve and over the rim. One of the tire technician's preferred shapes for easiest tire mounting.*



**Many sizes  
to choose from:**

Length	Diameter
18"	9/16", 5/8", 11/16"
24"	9/16", 5/8", 11/16"
30"	11/16", 3/4"

KEN-TOOL • 768 E. North Street, Akron, OH 44305

Toll Free: 888-536-8665 • Fax: 800-872-4929 • Phone: 330-535-7177 • Fax: 330-535-1345

E-mail: sales@kentool.com • www.kentool.com

KT102109



## New Heavy-Duty Double-End Spoon Combinations

Many size and shape combinations available to meet your specific needs.

Use the 18" and 24" spoons to mount or demount passenger car, motorcycle, ATV, and light truck tires. The 30" spoons provide enough strength and leverage to work on large truck, bus, off-road vehicle, tractor, and aircraft tires.

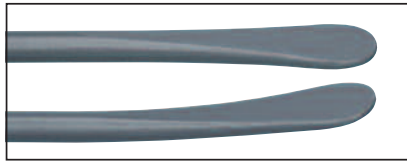

### Straight / Curved Combination

Model No.	Length	Diameter
31830	18"	9/16"
31840	18"	5/8"
31850	18"	11/16"

Model No.	Length	Diameter
32430	24"	9/16"
32440	24"	5/8"
32450	24"	11/16"

Model No.	Length	Diameter
33050	30"	11/16"
33060	30"	3/4"

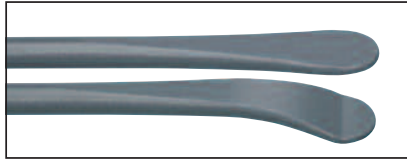

### Straight / Curved with Flat Tip Combination

Model No.	Length	Diameter
31831	18"	9/16"
31841	18"	5/8"
31851	18"	11/16"

Model No.	Length	Diameter
32431	24"	9/16"
32441	24"	5/8"
32451	24"	11/16"

Model No.	Length	Diameter
33051	30"	11/16"
33061	30"	3/4"

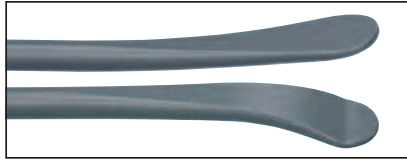

### Curved / Curved with Flat Tip Combination

Model No.	Length	Diameter
31832	18"	9/16"
31842	18"	5/8"
31852	18"	11/16"

Model No.	Length	Diameter
32432	24"	9/16"
32442	24"	5/8"
32452	24"	11/16"

Model No.	Length	Diameter
33052	30"	11/16"
33062	30"	3/4"

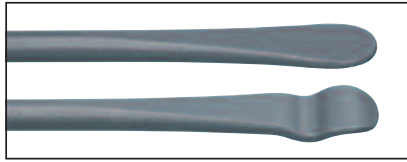

### Straight / Drop-Center Combination

Model No.	Length	Diameter
31833	18"	9/16"
31843	18"	5/8"
31853	18"	11/16"

Model No.	Length	Diameter
32433	24"	9/16"
32443	24"	5/8"
32453	24"	11/16"

Model No.	Length	Diameter
33053	30"	11/16"
33063	30"	3/4"

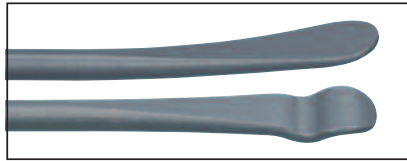

### Curved / Drop-Center Combination

Model No.	Length	Diameter
31834	18"	9/16"
31844	18"	5/8"
31854	18"	11/16"

Model No.	Length	Diameter
32434	24"	9/16"
32444	24"	5/8"
32454	24"	11/16"

Model No.	Length	Diameter
33054	30"	11/16"
33064	30"	3/4"

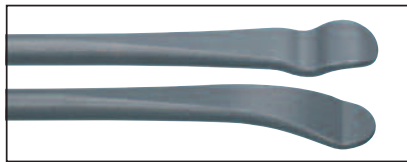

### Drop-Center / Curved with Flat Tip Combination

Model No.	Length	Diameter
31835	18"	9/16"
31845	18"	5/8"
31855	18"	11/16"

Model No.	Length	Diameter
32435	24"	9/16"
32445	24"	5/8"
32455	24"	11/16"

Model No.	Length	Diameter
33055	30"	11/16"
33065	30"	3/4"



Mount



Demount

## New\* Single-End Spoons



Model No.	Description	Length	Diameter
32101	Straight	18"	11/16"
32119	Straight	24"	11/16"
33219	Straight	30"	11/16"
33022*	Straight	30"	3/4"
33238	Straight	30"	7/8"
32102	Curved	18"	11/16"
32120	Curved	24"	11/16"
33220	Curved	30"	11/16"
33023*	Curved	30"	3/4"
33239	Curved	30"	7/8"

Model No.	Description	Length	Diameter
32121	Drop-Center	18"	11/16"
34121	Drop-Center	24"	11/16"
33020*	Drop-Center	30"	11/16"
33024*	Drop-Center	30"	3/4"
34122	Drop-Center	30"	7/8"
31820*	Curved w/Flat	18"	11/16"
32420*	Curved w/Flat	24"	11/16"
33021*	Curved w/Flat	30"	11/16"
33025*	Curved w/Flat	30"	3/4"
33026*	Curved w/Flat	30"	7/8"

## Double-End Tire Irons for Small Tires



Pro tire changing tools for small tires. Ideal for mounting and demounting motorcycle, ATV, lawn tractor, golf cart, and small tires by hand. Rounded ends will not pinch tube. Patented.



Model No.	Length	Diameter
32109	9"	7/16"
32116	16"	7/16"
32110	2 pc. Carded Set - Contains 2 #32109 9" Bars	
32117	2 pc. Carded Set - Contains 2 #32116 16" Bars	

**Ken-Tool®**  
WHEREVER TIRES ARE CHANGED™

# SPECIALTY SOCKETS

Torque Sticks & Extensions • Twist Sockets • Flip Sockets • Impact Sockets



## TorqueMaster™ Torque Sockets

For foreign and domestic cars and light trucks. Tighten nuts to factory specifications each time the wheels are replaced. Color and letter coded for quick size and torque reference. Converts any impact gun, including those with an extended anvil, into an instant torque wrench by bleeding torque off the impact gun. Application chart can be wall mounted. (Application Charts No. 30199 and No. 30299 are also available separately.) Limited lifetime warranty.



### Individual Sockets 1/2" Drive

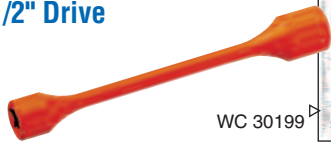

Model	Description	Socket Opening	Torque Limit	Weight
30181	Brown (A)	13/16"	100 ft-lbs	.5 lbs (.2 kg)
30182	Orange (B)	21 mm	80 ft-lbs	.5 lbs (.2 kg)
30183	Gray (C)	19 mm (3/4")	100 ft-lbs	.5 lbs (.2 kg)
30184	Black (D)	21 mm	60 ft-lbs	.5 lbs (.2 kg)
30185	Blue (E)	19 mm (3/4")	80 ft-lbs	.5 lbs (.2 kg)
30186	Yellow (F)	19 mm (3/4")	65 ft-lbs	.5 lbs (.2 kg)
30187	Red (G)	17 mm	80 ft-lbs	.5 lbs (.2 kg)
30188	Dark Green (H)	17 mm	45 ft-lbs	.5 lbs (.2 kg)
30189	White (I)	7/8"	120 ft-lbs	.5 lbs (.2 kg)
30195	Tan (J)	1"	140 ft-lbs	.5 lbs (.2 kg)
30196	Light Purple (K)	17 mm	110 ft-lbs	.5 lbs (.2 kg)
30197	Green (L)	1"	170 ft-lbs	.5 lbs (.2 kg)
30198	Crimson Red (V)	1-1/16"	140 ft-lbs	.5 lbs (.2 kg)
30200	Aqua (Q)	7/8"	140 ft-lbs	.5 lbs (.2 kg)
30201	Bright Green (T)	15/16"	135 ft-lbs	.5 lbs (.2 kg)
30202	Navy Blue (Y)	7/8"	100 ft-lbs	.5 lbs (.2 kg)
30203	Light Tan (Z)	7/8"	65 ft-lbs	.5 lbs (.2 kg)
30204	Turquoise (BB)	21 mm	150 ft-lbs	.5 lbs (.2 kg)
<b>NEW</b> 30205	Light Pink (CC)	17mm	90 ft-lbs	.5 lbs (.2 kg)
<b>NEW</b> 30206	Sky Blue (DD)	21mm	100 ft-lbs	.5 lbs (.2 kg)
<b>NEW</b> 30207	Safety Purple (EE)	22mm	140 ft-lbs	.5 lbs (.2 kg)
<b>NEW</b> 30208	Yellow Gray (FF)	19mm	180 ft-lbs	.5 lbs (.2 kg)
<b>NEW</b> 30211	Quartz Gray (KK)	19mm	120 ft-lbs	.5 lbs (.2 kg)
<b>NEW</b> 30212	Fuchsia (LL)	22mm	175 ft-lbs	.5 lbs (.2 kg)
<b>NEW</b> 30213	Gold (NN)	19mm	90 ft-lbs	.5 lbs (.2 kg)
<b>NEW</b> 30214	Salmon (QQ)	22mm	95 ft-lbs	.5 lbs (.2 kg)
<b>NEW</b> 30216	Deep Purple (UU)	14mm	75 ft-lbs	.5 lbs (.2 kg)
<b>NEW</b> 30217	Vanilla (XX)	13/16"	160 ft-lbs	.5 lbs (.2 kg)
<b>NEW</b> 30218	Honey Yellow (JJ)	19mm	145 ft-lbs	.5 lbs (.2 kg)
<b>NEW</b> 30222	Silver Sparkle (SS)	21mm	110 ft-lbs	.5 lbs (.2 kg)
30199	11" x 17" Application Wall Chart (WC)			
<b>NEW</b> 30299	22" x 24" Laminated Socket Torque Wall Chart			

### Individual Torque Extensions



Model	Description	Drive Size Socket/Opening	Torque Limit	Weight
<b>NEW</b> 30255	Black Oxide (A)	3/8"	30 ft-lbs	.5 lbs (.2 kg)
<b>NEW</b> 30256	Black Oxide (B)	3/8"	40 ft-lbs	.5 lbs (.2 kg)
<b>NEW</b> 30257	Black Oxide (C)	3/8"	50 ft-lbs	.5 lbs (.2 kg)
<b>NEW</b> 30258	Black Oxide (D)	3/8"	60 ft-lbs	.5 lbs (.2 kg)
<b>NEW</b> 30219	Orange (B)	1/2"	160 ft-lbs	.7 lbs (.3 kg)
30220	Aqua (Q)	1/2"	140 ft-lbs	.7 lbs (.3 kg)
<b>NEW</b> 30221	Light Blue (S)	1/2"	55 ft-lbs	.7 lbs (.3 kg)
30223	Gray (C)	1/2"	100 ft-lbs	.7 lbs (.3 kg)
<b>NEW</b> 30224	Black (D)	1/2"	60 ft-lbs	.7 lbs (.3 kg)
30225	Blue (E)	1/2"	80 ft-lbs	.7 lbs (.3 kg)
30226	Yellow (F)	1/2"	65 ft-lbs	.7 lbs (.3 kg)
<b>NEW</b> 30227	Fuchsia (LL)	1/2"	175 ft-lbs	.7 lbs (.3 kg)
<b>NEW</b> 30228	Dark Green (H)	1/2"	45 ft-lbs	.7 lbs (.3 kg)
30229	White (I)	1/2"	120 ft-lbs	.7 lbs (.3 kg)
<b>NEW</b> 30243	Turquoise (G)	1/2"	150 ft-lbs	.7 lbs (.3 kg)
<b>NEW</b> 30244	Bright Green (T)	1/2"	135 ft-lbs	.7 lbs (.3 kg)
<b>NEW</b> 30247	Gold (NN)	1/2"	90 ft-lbs	.7 lbs (.3 kg)
<b>NEW</b> 30248	Light Purple (K)	1/2"	110 ft-lbs	.7 lbs (.3 kg)
<b>NEW</b> 30249	Neon Yellow (OO)	1/2"	75 ft-lbs	.7 lbs (.3 kg)
<b>NEW</b> 30250	Green (L)	1/2"	170 ft-lbs	.7 lbs (.3 kg)

### Individual Heavy-Duty Truck Torque Extensions

Convert your own sockets into torque sockets for use on commercial, heavy-duty trucks, and buses.



Model	Description	Drive Size Socket/Opening	Torque Limit	Weight
30230	Yellow (O)	3/4"	175 ft-lbs	.75 lbs (.3 kg)
30231	Yellow (N)	3/4"	250 ft-lbs	.75 lbs (.3 kg)
30232	Yellow (U)	3/4"	350 ft-lbs	.75 lbs (.3 kg)
30233	Yellow (M)	3/4"	475 ft-lbs	.75 lbs (.3 kg)
30236	Yellow (T)	1"	175 ft-lbs	1 lb (.5 kg)
30237	Yellow (R)	1"	250 ft-lbs	1 lb (.5 kg)
30238	Yellow (S)	1"	350 ft-lbs	1 lb (.5 kg)
30239	Yellow (P)	1"	475 ft-lbs	1 lb (.5 kg)
30240	Yellow (W)	1"	650 ft-lbs	1 lb (.5 kg)
<b>NEW</b> 30241	Yellow (Q)	1"	300 ft-lbs	1 lb (.5 kg)
<b>NEW</b> 30242	Yellow (Y)	1"	550 ft-lbs	1 lb (.5 kg)

**WARNING:** Torque sockets and truck torque extensions cannot be used to take off wheel nuts. Calibrate your impact gun and follow all manufacturers' recommended procedures when using Torque Master products.



# TorqueMaster™ Torque Socket Kits & Sets

## Torque Socket Kits



Tighten lug nuts to factory specifications. Color and letter coded for quick size and torque reference.

	<b>Four Pc. Kit</b>	<b>Six Pc. Kit</b>	<b>Nine Pc. Kit</b>	<b>Ten Pc. Kit</b>	<b>Twelve Pc. Kit</b>
Model No. 30174	Model No. 30176	Model No. 30179	Model No. 30180	Model No. 30190	
Wt: 4.4 lbs. (2.0 kg)	Wt: 6.9 lbs. (3.1 kg)	Wt: 8.75 lbs. (4 kg)	Wt: 9.5 lbs. (4.3 kg)	Wt: 10.5 lbs. (4.8 kg)	

<b>30181</b> - Brown (A)	100 ft-lbs	●	●	●	●	●
<b>30182</b> - Orange (B)	80 ft-lbs		●	●	●	●
<b>30183</b> - Gray (C)	100 ft-lbs	●	●	●	●	●
<b>30184</b> - Black (D)	60 ft-lbs		●	●	●	●
<b>30185</b> - Blue (E)	80 ft-lbs	●	●	●	●	●
<b>30186</b> - Yellow (F)	65 ft-lbs		●	●	●	●
<b>30187</b> - Red (G)	80 ft-lbs		●	●	●	●
<b>30188</b> - Dark Green (H)	45 ft-lbs		●	●	●	●
<b>30189</b> - White (I)	120 ft-lbs	●	●	●	●	●
<b>30200</b> - Aqua (Q)	140 ft-lbs			●	●	●
<b>30202</b> - Navy Blue (Y)	100 ft-lbs			●	●	●
<b>30213</b> - Gold (NN)	90 ft-lbs			●	●	●



### Four Piece Kit for SUV's Most Popular Sizes for Largest Growing Market

For domestic and foreign SUV's.

Set contains:

<b>30181</b> - Brown (A)	100 ft-lbs.
<b>30183</b> - Gray (C)	100 ft-lbs.
<b>30200</b> - Aqua (Q)	140 ft-lbs.
<b>30204</b> - Turquoise (BB)	150 ft-lbs.

Model	Item No.	Weight
30175	30175	4.5 lbs (2 kg)

## Torque Extension Kits

Convert your own sockets into torque sockets. Color and letter coded for quick size and torque reference.

	<b>Four Pc. Set</b>	<b>Five Pc. Set</b>	<b>Ten Pc. Kit</b>
Model No. 30234	Model No. 30235	Model No. 30251	
Wt: 3 lbs. (1.3 kg)	Wt: 4 lbs. (1.8 kg)	Wt: 7.6 lbs. (3.5 kg)	

<b>30220</b> - Aqua (Q)	140 ft-lbs	●	●	●
<b>30223</b> - Gray (C)	100 ft-lbs	●	●	●
<b>30224</b> - Black (D)	60 ft-lbs		●	●
<b>30225</b> - Blue (E)	80 ft-lbs	●	●	●
<b>30226</b> - Yellow (F)	65 ft-lbs	●	●	●
<b>30228</b> - Dark Green (H)	45 ft-lbs		●	●
<b>30229</b> - White (I)	120 ft-lbs	●	●	●
<b>30248</b> - Light Purple (K)	110 ft-lbs		●	●
<b>30249</b> - Neon Yellow (OO)	75 ft-lbs		●	●
<b>30274</b> - Gold (NN)	90 ft-lbs		●	●

### For Passenger Cars



Four Pc. Kit



Five Pc. Kit

### For Passenger Cars and Light Trucks



Ten Pc. Kit



# Wheel Cover & Wheel-Lock Removal Kits

## Nine Piece Wheel Cover & Wheel-Lock Removal Kits

Remove and replace GM, Ford, Chrysler hubcap locks and aftermarket wheel lug locks without the factory issued key. Save time! Will not damage the lock or stud.

Set contains:

- 30170-10** Ford & Chrysler Hubcap Locks/ Lg. GM Triangle Wheel Locks
- 30170-20** GM Spline Hubcap Locks
- 30170-30** GM Hubcap Locks
- 30170-40** 18mm Lugs/GM Wheel Cover Locks/Ford Wheel Locks
- 30170-50** Corvette/GM "N" & "F" Body Wheel Locks
- 30170-60** Std. McGard-Style Wheel Locks/ Lg. GM Wheel Cover
- 30170-70** Oversized McGard-Style Wheel Locks
- 30170-80** Punch
- 30170-90** Lg. Dia. Chrysler Lock



Model	Item No.	Weight
30170	30170	3.1 lbs (1.4 kg)

## Thirteen Piece Deluxe Wheel Cover & Wheel-Lock Removal Kits

Set contains:

- 30170-10** Ford & Chrysler Hubcap Locks/ Lg. GM Triangle Wheel Locks
- 30170-20** GM Spline Hubcap Locks
- 30115-02** 3/4", 19mm Damaged Wheel Lug & Oversized Wheel Lock Remover
- 30170-30** GM Hubcap Locks
- 30115-05** 7/8" Damaged Wheel Lug & Oversized Wheel Lock Remover
- 30170-40** 18mm Lugs/GM Wheel Cover Locks/Ford Wheel Locks
- 30171-45** 18mm Nut/Corvette GM Lock
- 30170-50** Corvette/GM "N" & "F" Body Wheel Locks
- 30170-60** Std. McGard-Style Wheel Locks/ Lg. GM Wheel Cover
- 30170-70** Oversized McGard-Style Wheel Locks
- 30170-80** Punch
- 30170-90** Lg. Dia. Chrysler Lock
- 30110-06** 3" Impact Extension



Model	Item No.	Weight
<b>NEW</b> 30171	30171	4.9 lbs (2.2 kg)

**LIMITED LIFETIME WARRANTY**



# Twist Sockets & Twist Socket Sets

Twist sockets are specifically designed to easily remove damaged, rounded or corroded nuts, wheel lugs, bolts, pipes, pipe nipples or studs. Simply place the socket so it barely catches the head of the fastener and turn with an air ratchet, hand ratchet, or breaker bar. The unique spiral fluting bites onto the damaged fastener and won't let go. Designed for general automotive applications.

## Five Piece Deep Twist Socket Set

Socket sizes:

- 30116-02 19mm, 3/4" socket
- 30116-04 13/16" socket
- 30116-05 7/8" socket
- 30116-07 15/16" socket
- 30116-08 1" socket



Model	Item No.	Description	Drive	Weight
30116	30116	5 Pc. Set w/Organizer Bar	1/2"	2.5 lbs (1.1 kg)

## Eight Piece Twist Socket Set

Socket sizes:

- 30117-06 6mm socket
- 30117-08 8mm socket
- 30117-10 10mm socket
- 30117-12 12mm socket
- 30117-13 13mm socket
- 30117-14 14mm socket
- 30117-15 15mm socket
- 30117-17 17mm socket



Model	Item No.	Description	Drive	Weight
30117	30117	8 Pc. Set w/Organizer Bar	1/4"	.9 lbs (.4 kg)

## Nine Piece Twist Socket Set

Socket sizes:

- 30106-05 10mm socket
- 30106-07 7/16", 11mm socket
- 30106-11 12mm socket
- 30106-13 13mm socket
- 30106-15 14mm socket
- 30106-19 15mm socket
- 30106-21 5/8", 16mm socket
- 30106-25 17mm socket
- 30106-27 3/4", 19mm socket



Model	Item No.	Description	Drive	Weight
30109	30109	9 Pc. Set w/Organizer Bar	3/8"	2.8 lbs (1.2 kg)

## Thirteen Piece Twist Socket Set

Socket sizes:

- 30106-01 3/8" socket
- 30106-05 10mm socket
- 30106-07 7/16", 11mm socket
- 30106-09 1/2" socket
- 30106-11 12mm socket
- 30106-13 13mm socket
- 30106-15 14mm socket
- 30106-17 9/16" socket
- 30106-19 15mm socket
- 30106-21 5/8", 16mm socket
- 30106-23 11/16" socket
- 30106-25 17mm socket
- 30106-27 3/4", 19mm socket



Model	Item No.	Description	Drive	Weight
30108	30108	13 Pc. Set w/Organizer Bar	3/8"	1.6 lbs (.7 kg)

## Ten Piece Slim Twist Socket Set with External Hex

Quickly removes damaged or rounded nuts, bolts, studs, and socket head cap screws in tight quarters. The through hole design allows them to also be used on long studs. Fits SAE sizes 3/8" to 3/4" and metric sizes from 9mm up to 19mm. Used where standard twist sockets will not fit. Can be used with an open-end wrench, or with a socket.

Socket sizes:

- 30270-01 9mm ; ext. hex 5/8" socket
- 30270-02 10mm, 3/8" ; ext. hex 5/8" socket
- 30270-03 11mm, 7/16" ; ext. hex 11/16" socket
- 30270-04 12mm ; ext. hex 3/4" socket
- 30270-05 13mm, 1/2" ; ext. hex 3/4" socket
- 30270-06 14mm, 9/16" ; ext. hex 13/16" socket
- 30270-07 15mm ; ext. hex 7/8" socket
- 30270-08 16mm, 5/8" ; ext. hex 15/16" socket
- 30270-09 17mm, 11/16" ; ext. hex 1" socket
- 30270-10 19mm, 3/4" ; ext. hex 1-1/16" socket



Model	Item No.	Description	Drive	Weight
30270	30270	10 Pc. Set w/Organizer Bar	3/8"	1 lb (.5 kg)
30271	30271	10 Pc. Set w/Plastic Case	3/8"	1 lb (.5 kg)

## Five Piece Twist Socket Set with Punch

Socket sizes:

- 30118-03 19mm, 3/4" socket
- 30118-04 13/16" socket
- 30118-05 7/8" socket
- 30118-06 15/16" socket
- 30118-07 1" socket
- 30170-80 Punch



Model	Item No.	Description	Drive	Weight
30118	30118	5 Pc. Set w/Plastic Case	1/2"	2 lbs (.9 kg)

## Nine Piece Twist Socket Set with Punch

Socket sizes:

- 30106-05 10mm socket
- 30106-07 7/16", 11mm socket
- 30106-11 12mm socket
- 30106-13 13mm socket
- 30106-15 14mm socket
- 30106-19 15mm socket
- 30106-21 5/8", 16mm socket
- 30106-25 17mm socket
- 30106-27 3/4", 19mm socket
- 30170-80 Punch



Model	Item No.	Description	Drive	Weight
30107	30107	9 Pc. Set w/Plastic Case	3/8"	1.5 lbs (.7 kg)

## Thirteen Piece Twist Socket Set with Punch

Socket sizes:

- 30106-01 3/8" socket
- 30106-05 10mm socket
- 30106-07 7/16", 11mm socket
- 30106-09 1/2" socket
- 30106-11 12mm socket
- 30106-13 13mm socket
- 30106-15 14mm socket
- 30106-17 9/16" socket
- 30106-19 15mm socket
- 30106-21 5/8", 16mm socket
- 30106-23 11/16" socket
- 30106-25 17mm socket
- 30106-27 3/4", 19mm socket
- 30170-80 Punch



Model	Item No.	Description	Drive	Weight
30106	30106	13 Pc. Set w/Plastic Case	3/8"	1.9 lbs (.9 kg)

## Individual Twist Sockets - Fluted



Model	Item No.	Socket Sizes	Fluted	Weight
30151	30151	3/4", 19mm & 13/16", 21mm	12	.4 lbs (.18 kg)
30152*	30152	3/4", 19mm & 13/16", 21mm	6	.4 lbs (.18 kg)
30153	30153	7/8" x 1"	12	.4 lbs (.18 kg)
30154*	30154	7/8" x 1"	6	.4 lbs (.18 kg)

\*Includes punch pin

You may also be interested in:  
**NO-MAR RIM GUARD™**

Protective plastic cover prevents damage to chrome and aluminum rims and wheels when removing or replacing lug nuts. Imprinted with torque sequence number for proper torquing of disc wheels.

Imported from Canada.

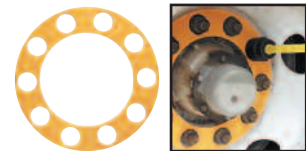

Model	Item No.	Weight
30605	30605	.5 lbs (.2 kg)



## Flip Sockets & Impact Socket Sets

### Three Piece Thinwall Flip Socket Set\*

One end is a standard 6-point socket for everyday use. Flip socket over and you have a 6-point socket of larger size.

Socket sizes:

- 30110-01** 19mm - 21mm socket
- 30110-02** 3/4" - 13/16" socket
- 30110-06** 3" extension



Model	Item No.	Drive	Weight
30110	30110	1/2"	1.2 lbs (.54 kg)

### Five Piece Thinwall Flip Socket Set\*

Socket sizes:

- 30110-01** 19mm - 21mm socket
- 30110-02** 3/4" - 13/16" socket
- 30119-03** 7/8" - 15/16" socket
- 30119-04** 17mm - 19mm socket
- 30110-06** 3" extension



Model	Item No.	Drive	Weight
30119	30119	1/2"	2.1 lbs (1 kg)

**NEW**

### Six Piece Double-Duty Flip Socket Set

One end is a standard 6-point socket for everyday use. Flip socket over and you have a 6-fluted twist socket for removing damaged or rounded wheel lugs.

Socket sizes:

- 30111-01** 17mm socket
- 30111-02** 19mm, 3/4" socket
- 30111-03** 21mm socket
- 30111-04** 13/16" socket
- 30111-05** 7/8" socket
- 30110-06** 3" extension



Model	Item No.	Drive	Weight
30111	30111	1/2"	2.8 lbs (1.2 kg)

### Six Piece Thick and Thin Flip Socket Set\*

For those ever changing aftermarket and manufacturers' wheels. One end is a standard 6-point socket for everyday use. Flip socket over and you have a thinwall socket of the same size for wheels with minimal clearance.

Socket sizes:

- 30112-01** 17mm socket
- 30112-02** 19mm, 3/4" socket
- 30112-03** 21mm socket
- 30112-04** 13/16" socket
- 30112-05** 7/8" socket
- 30110-06** 3" extension



Model	Item No.	Drive	Weight
30112	30112	1/2"	3 lbs (1.3 kg)

### Six Piece Deep Thinwall Impact Socket Set\*

For the difficult aftermarket and manufacturers' wheels.

Socket sizes:

- 30113-01** 17mm socket
- 30113-02** 19mm, 3/4" socket
- 30113-03** 21mm socket
- 30113-04** 13/16" socket
- 30113-05** 7/8" socket
- 30110-06** 3" extension



Model	Item No.	Drive	Weight
30113	30113	1/2"	3 lbs (1.3 kg)

### Five Piece Double-Duty Oil Drain Plug Removal Flip Socket Set

One end is a standard 6-point socket for everyday use. Flip socket over and you have a twist socket damaged oil drain plug remover of the same size.

Socket sizes:

- 30114** 17mm socket
- 30114** 19mm, 3/4" socket
- 30114-03** 14mm socket
- 30114-04** 15mm socket
- 30114-05** 16mm, 5/8" socket



Model	Item No.	Drive	Weight
30114	30114	3/8"	3 lbs (1.3 kg)

### Three Piece Lug and Lock Flip Socket Set

One end is a standard 6-fluted twist socket for removing damaged wheel lugs. Flip socket over and you have a 12-fluted twist socket for removing wheel locks.

Socket sizes:

- 30115-02** 19mm, 3/4" socket
- 30115-05** 7/8" socket
- 30110-06** 3" extension



Model	Item No.	Drive	Weight
30115	30115	1/2"	1.6 lbs (.7 kg)

### Three Piece 6-Fluted Twist Flip Socket Set

Socket sizes:

- 30152** 19mm & 13/16", 21mm socket, 6-Fluted
- 30154** 7/8" & 1" socket
- 30110-06** 3" extension



Model	Item No.	Description	Drive	Weight
<b>NEW</b> 30101	30101	3 Pc. Set w/Plastic Case	1/2"	1.3 lbs (.6 kg)

### Three Piece 12-Fluted Twist Flip Socket Set

Socket sizes:

- 30151** 19mm & 13/16", 21mm socket
- 30153** 7/8" & 1" socket
- 30110-06** 3" extension



Model	Item No.	Description	Drive	Weight
<b>NEW</b> 30102	30102	3 Pc. Set w/Plastic Case	1/2"	1.3 lbs (.6 kg)

### Three Piece 6-Pt. & 12-Fluted Twist Flip Socket Set

Socket sizes:

- 30103-01** 17mm socket
- 30103-02** 19mm socket
- 30110-06** 3" extension



Model	Item No.	Description	Drive	Weight
<b>NEW</b> 30103	30103	3 Pc. Set w/Plastic Case	1/2"	1.3 lbs (.6 kg)



## Impact Extensions



30110-06



30245

1" sq. dr. male x 1" sq. dr. female 13" impact extension. Provides access to hard-to-reach areas with 1" impact socket applications.



30246

3/4" sq. dr. male x 1" sq. dr. male 13" extension. Provides access to deep budd wheels.

Model	Item No.	Description	Weight
	30110-06	3" Impact Extension	.4 lbs (.18 kg)
<b>NEW</b>	30245	1" Drive x 13" Impact Extension	.4 lbs (.18 kg)
<b>NEW</b>	30246	3/4" Sq. Dr. Male x 1" Sq. Dr. Male 13" Impact Ext	.4 lbs (.18 kg)

## LIMITED LIFETIME WARRANTY

\*Thinwall sockets have a two-year warranty with proof of purchase

**NEW**

**Ken-Tool®**  
WHEREVER TIRES ARE CHANGED™

# UNIVERSAL MASTER TPMS SENSOR HARDWARE & TOOL SERVICE SET



Part No. 30000

**NO MORE GUESSING!**  
Now you can have all of the tools and hardware you need to service most TPMS sensors — right at your fingertips!

**Versatile 152-pc assortment (15 unique kits) covers over 55 different OEM sensor models & 90% of US vehicles**

- Hardware kits contain valve core & cap, mounting nut, gasket(s), washer(s), &/or valve stem
- Includes the new rubber snap-in valve stem kits with sensor screws used by GM
- Plus 50 extra valve cores / 50 extra valve caps / complete Application & Torque Guide

**TPMS service tools include:**

- Ken-Tool's unique TPMS Sentry™ sensor service tool<sup>1</sup>
- 1/4"-drive Ratcheting Torque Wrench<sup>2</sup> with 11mm & 12mm deep Sockets<sup>3</sup> for mounting nuts
- Torque Driver for valve cores<sup>4</sup>
- Torque Driver<sup>5</sup> & T-10/T-15 TORX® bits for rubber snap-in valve stem self-tapping screws

**In 3" x 9" x 16" Portable Poly Case, 6-lbs. Replacement Hardware Kits Available From Ken-Tool**

**OEM HARDWARE RECOMMENDED REPLACEMENT**

Most OEM sensor manufacturers recommend that the TPMS valve hardware kit be replaced whenever the valve is removed or loosened from the sensor to ensure the system is working properly. Once the valve or sensor is loosened, original and worn components are more likely to allow air to leak or escape. Replacing old components helps the TPMS sensor function properly when the tire is remounted on the vehicle.

**TPMS Sentry™ Sensor Service Tool**

Designed to keep the sensor in a safe and secure position after the mounting nut has been removed and the sensor is released from the wheel.

Part No. 30209



**KEN-TOOL • 768 E. North Street, Akron, OH 44305**

**Toll Free: 888-536-8665 • Fax: 800-872-4929 • Phone: 330-535-7177 • Fax: 330-535-1345**

**E-mail: sales@kentool.com • www.kentool.com**

KT030108



**NEW**

**Ken-Tool®**

WHEREVER TIRES ARE CHANGED™



Part No. 7326

## BEARING & ROTOR PULLING SYSTEM

Now with expanded vehicle applications!

*Pull and press any hub or bearing on domestic and import vehicles!  
Done completely on vehicle – no need to remove the  
knuckle assembly and re-align the front end.*

- Made in USA from quality, high-grade steel
- Heat-treated for top performance and long life
- Includes everything you need to do the job



**13 New  
components!**



**No. 7326U Upgrade Kit  
available for previous Hub-Shark™ owners  
(case included)**

**NEW**

**Ken-Tool®**  
WHEREVER TIRES ARE CHANGED™



# SAFETY FIRST

## EASY-LIFT™ BEAD SEATING STAND

**ERGONOMIC: Reduces Back Strain While Handling 22.5" Tire & Wheel Assemblies**

Aligns beads concentrically on wheel for improved ride & longer tire life.



### Easy operation with less back strain:

- With hub facing out, simply roll mounted tire and wheel assembly to front of stand
- Push assembly onto crown – tire and wheel will automatically fall onto center of stand and rest with bead centered on bottom wheel flange
- Seat beads by inflating tire to 4-psi (max.)
- Step around stand and easily lift assembly into vertical position
- Roll assembly into tire inflation safety cage for final inflation
- Portable for field service, or can be bolted to the floor
- 24"H x 26"W x 27"L
- Made of high grade steel

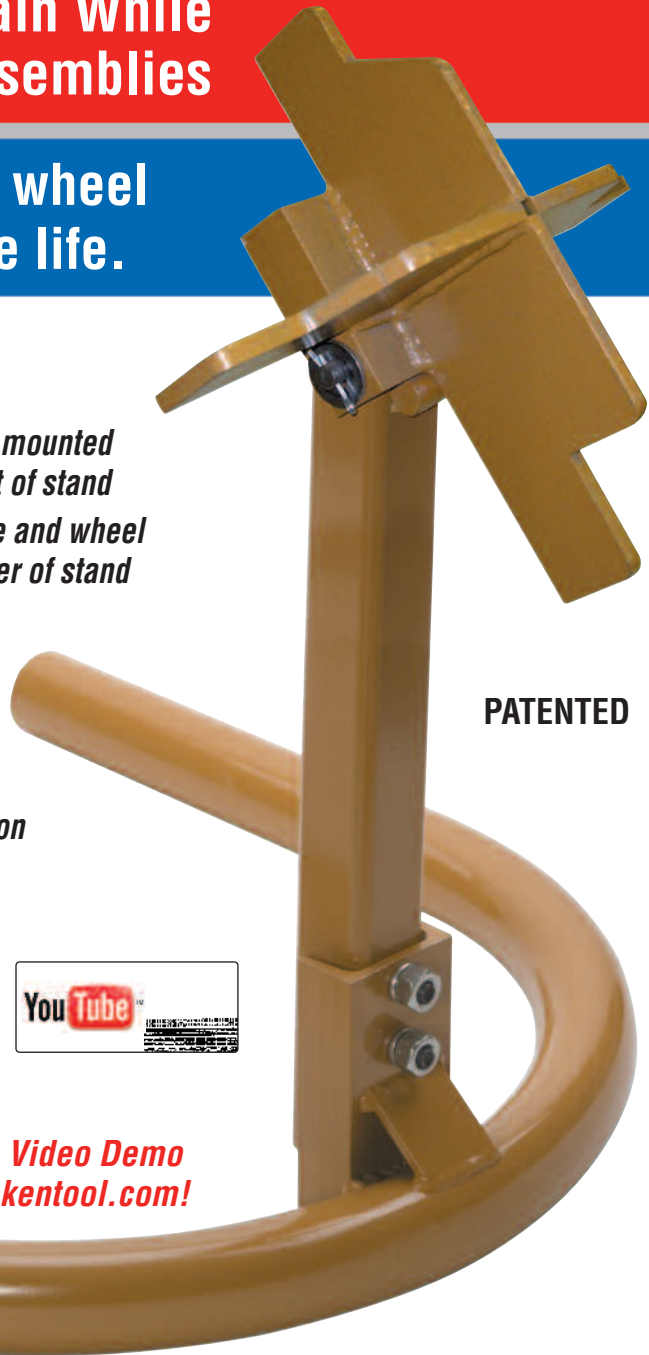

PATENTED



See the Video Demo at [www.kentool.com](http://www.kentool.com)!



Model No.	Description	Weight
36016	Std. Crown for 8-3/4" dia. hubs	36-lbs.
36017	Large Crown for 11" Euro hubs	37-lbs.

KEN-TOOL • 768 E. North Street, Akron, OH 44305

Toll Free: 888-536-8665 • Fax: 800-872-4929 • Phone: 330-535-7177 • Fax: 330-535-1345

E-mail: [sales@kentool.com](mailto:sales@kentool.com) • [www.kentool.com](http://www.kentool.com)

KT030308

**NEW**

**Ken-Tool®**

WHEREVER TIRES ARE CHANGED™

# INDUSTRIAL WHEEL LOCK RING TOOL SET

**EASIER, FASTER, SAFER.**  
Specially designed to remove & replace lock rings on multi-piece industrial forklift wheels

*Having the right tool does make a difference.*

*Removing and replacing lock rings on multi-piece industrial wheels presents its own set of unique problems – these tools are specifically designed to make that job easier, faster, and safer.*

- *Helps prevent injury – easier to keep hands safely outside of press cage!*
- *Tools are powder coated to protect from rust and corrosion; bright orange color helps prevent lost tools*
- *Forged from high-grade carbon steel and heat-treated for long-lasting strength and durability*

**Part No. 32129**  
**2 Pc. Industrial Wheel Lock Ring Set**  
**Includes:**



Model No.	Description	Length	Weight
32130	Mount Demount Tool	15-3/4"	1.8 lbs
32131	Demount Prep Tool	15-1/2"	1.5 lbs

Part No. 32130  
Mount / Demount Tool

Part No. 32131  
Demount Prep Tool

PATENT PENDING

Demount end

Separator end

Pry-out end

Mount end

## No. 32130 Mount / Demount Tool



- **Demount end**  
*Lifts split ring progressively around wheel until fully demounted*



- **Mount end**  
*Used to mount split ring*

## Part No. 32131 Demount Prep Tool



- **Separator end**  
*Separates split ring from solid flange ring to form gap*



- **Pry-out end**  
*Reaches behind slotted end of split ring to pry it out and over the flange of the wheel*



**See the Video Demo**  
**at [www.kentool.com](http://www.kentool.com)!**

KEN-TOOL • 768 E. North Street, Akron, OH 44305

Toll Free: 888-536-8665 • Fax: 800-872-4929 • Phone: 330-535-7177 • Fax: 330-535-1345

E-mail: [sales@kentool.com](mailto:sales@kentool.com) • [www.kentool.com](http://www.kentool.com)

KT041408

**NEW**

**Ken-Tool®**  
WHEREVER TIRES ARE CHANGED™

# TIRE & WHEEL SERVICE CENTER

Featuring 21 of Ken-Tool's most popular tire tool products!



*Eye-catching 15" x 17" full color display card with photos and descriptions!*

*Convenient mobile base makes positioning for optimum sales a breeze!*

*Besides featuring 21 of Ken-Tool's most popular tire tool products, this new merchandiser attracts attention! It features a large 15" x 17" color display card at eye level with high-res color photos and descriptions of some of our best selling products. Each photo has a box so that a 1" x 2.5" barcode price label can be added. The sturdy 12" x 16" freestanding, powder-coated wire rack features bright color graphics to let your customers know they are buying Ken-Tool's professional quality tire tools and lug wrenches. Included at no extra cost is a 3" high 4-wheel dolly with strong and durable caster wheels to enable the loaded rack to be easily moved to different locations and to facilitate floor cleaning. The rack and dolly take up a small 15" x 16" footprint and can be placed on the floor or, without the dolly, on a standard 18" gondola base shelf.*

Part No.	Description	Quantity
35110	18" 35110 USA HICKORY TIRE KNOCKER	2
32119	24" T19 STRAIGHT TIRE SPOON	2
33220	30" T20A CURVED TIRE SPOON	2
34645	37" T45A® TUBELESS TIRE IRON	2
34645C	37" T45AC® CLASSIC TUBELESS TIRE IRON	2
34647	41" T45HD HD TUBELESS TIRE IRON	2
34747	36" T46A TUBELESS TIRE IRON	2
35323	16-1/2" T35 HD TIRE HAMMER, WOOD HANDLE	1
35429	32" TG11E BEAD BREAKING WEDGE, FIBERGLASS HANDLE	1
35637	18" 35637 PASSENGER 4-WAY LUG WRENCH, SAE/METRIC	2
35638	23" 35638 LIGHT TRUCK/RV 4-WAY LUG WRENCH, SAE/METRIC	2
35595	27" TC95 HD TRUCK LUG WRENCH, POPULAR LUG SIZES	1
30720	Wire Rack	1
36047-10	Planogram Card with Tie Strap	1

KEN-TOOL • 768 E. North Street, Akron, OH 44305

Toll Free: 888-536-8665 • Fax: 800-872-4929 • Phone: 330-535-7177 • Fax: 330-535-1345

E-mail: sales@kentool.com • www.kentool.com



## Professional Tire Tool and Lug Wrench Merchandisers

*Comerciantes de llaves y herramientas para llantas profesionales*  
*Présentoirs de clés à goujon et de démonte-pneus professionnels*



35648

Ken-Tool offers a simple, yet effective way to merchandise our top products. With assortment #36046 you get 15 of our best selling tools. Assortment #36045 offers a larger assortment of 20 equally fast-selling tire and wheel service tools. Both assortments come complete with a sturdy, freestanding wire rack (no assembly required). The graphics on the front of the rack let your customer know they're buying professional quality tire tools and lug wrenches from Ken-Tool while the userfriendly design of the rack lets you know you found the solution to displaying Ken-Tool products. Both the wire rack and planogram card can be purchased separately.

### 10 Piece Lug Wrench Assortment with rack No. 35648

*10 piezas. Surtido de llaves para ruedas con soporte No. 35648*  
*Jeu de clés à goujon avec râtelier de 10 pièces no 35648*

Part No.	Description	Quantity
35620	T9520 4-Way Wrench	2
35636	T56 Deluxe Metric 4-Way Wrench	1
35657	T57 4-Way Lug Nut Wrench	2
35659	T59 4-Way Lug Nut Wrench	2
35663	T63 Metric 4-Way Wrench	1
35690	90 4-Way Wrench - Truck	2
35648-01	Empty Display Stand	1



36045

### Deluxe Tire & Wheel Service Center No. 36045

*Centro de mantenimiento para ruedas y llantas de lujo No. 36045*  
*Centre de service de luxe pneus et roues no 36045*

Part No.	Description	Quantity
32318	22" TR5 Truck Wrench Handle/Leverage Bar	2
32501	16" TR1 1-1/8" Hex with 13/16" Sq. x 1-1/2" Hex Double-End Wrench	1
32508	16" TR98 1-1/2" Hex x 13/16" Sq. Double-End Wrench	1
32509	16" TR9 1-1/4" Hex x 1-1/16" Hex Double-End Wrench	1
32552	16" TRM2 24mm x 33mm Double-End Wrench"	1
33220	30" T20A Curved Tire Spoon	2
33223	30" T23A Truck Lock Ring Removal Tool	1
34645	37" T45A Truck Tire Mount/Demount Iron	2
34647	41" T45HD Truck Tire Mount/Demount Iron	1
35229	31" TG11EH Fiberglass Replacement Handle (fits 35429)	1
35323	16.5" T35 Hickory Handled Tire Hammer	1
35429	32" TG11E Fiberglass Handled Bead Breaking Wedge	1
35690	25" T90 Light Truck 4-Way, Welded - SAE	2
35595	27" TC95 Heavy-Duty Truck 4-Way, Drop-Forged - SAE	2
35924	46" T24B Slide-Action, Impact Bead Breaker	1
30720	Wire Rack	1
36045-10	Planogram Card with Tie Strap	1



36046

### Tire & Wheel Service Center No. 36046

*Centro de mantenimiento para ruedas y llantas No. 36046*  
*Centre de service pneus et roues no 36046*

Part No.	Description	Quantity
32116	16" Small Tire Mount/Demount Spoon	2
33220	30" T20A Curved Tire Spoon	1
33223	30" T23A Truck Lock Ring Removal Tool	1
34645	37" T45A Truck Tire Mount/Demount Iron	2
35129	30" T11EH Hickory Replacement Handle (fits 35329)	1
35229	31" TG11EH Fiberglass Replacement Handle (fits 35429)	1
35429	31" TG11E Fiberglass Handled Bead Breaking Wedge	1
35620	20" T9520 Economy Passenger Car 4-Way - SAE	1
35657	23" T57 Professional Gold Passenger Car 4-Way - SAE	1
35659	22" T59 Professional Passenger Car 4-Way - SAE	1
35663	18" T63 Economy Passenger Car 4-Way - Metric	1
35690	25" T90 Light Truck 4-Way, Welded - SAE	1
35695	27" T95 Heavy-Duty Truck 4-Way, Drop-Forged - SAE	1
30720	Wire Rack	1
36046-10	Planogram Card with Tie Strap	1

**All of Ken-Tool's Professional Vises feature:**



- 360° swivel base
- Machined base plate for smooth swivel
- Heavy-duty jaw beam covers screw
- Built-in anvils

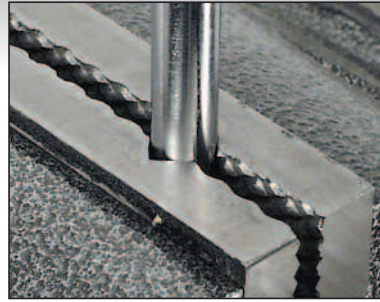

Jaw faces have "V" notches for vertical gripping

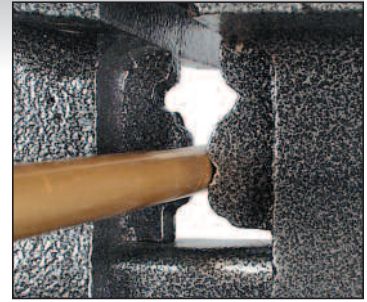

Built-in pipe jaws

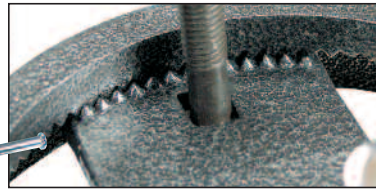

- Gear-type locking system with double lock-down bolts - locks vise securely in position



"V" notched, replaceable/reversible jaws made of carbon steel and heat-treated for extra strength, diamond cut on one side - smooth on the other

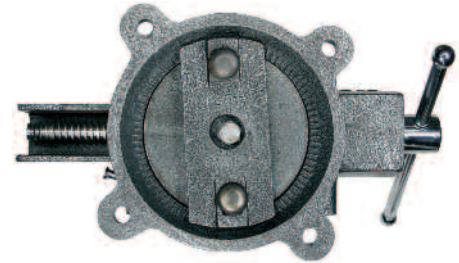
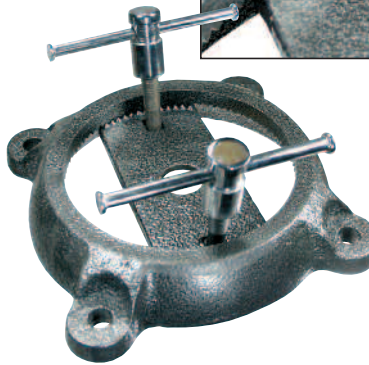

**Professional Reversible Mechanic's Vises feature:**

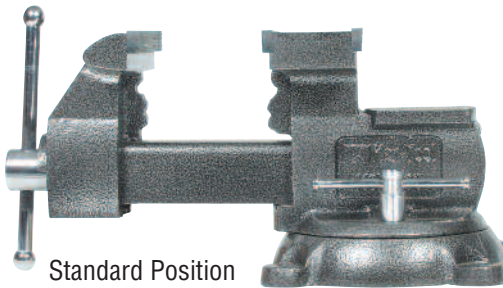

Standard Position

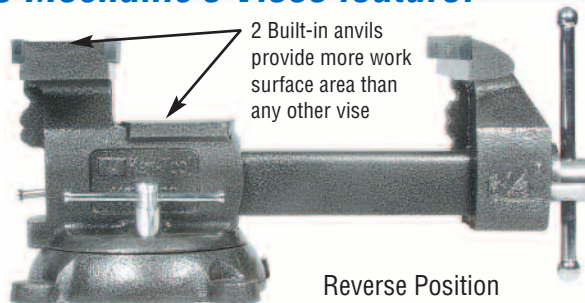

Reverse Position

2 Built-in anvils provide more work surface area than any other vise

It's simple...Remove the jaw from the front of the base, swivel the base 180°, then re-insert the jaw:



## Professional Workshop Vises

*Tornillos de banco para taller profesionales*

*Étaux pour ateliers professionnels*

With high quality construction for extra durability and full-strength performance at any jaw opening, these vises are made for the professional - strong, durable, and built to last.

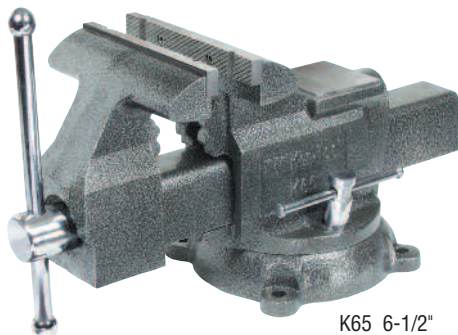

K65 6-1/2"

Model	Item No.	Jaw Width	Jaw Opening	Throat Depth	Pipe Jaw Capacity	Weight
K55	64055	5-1/2" 14 cm	6-1/2" 17 cm	3-3/16" 8 cm	1/8" - 2-1/2" .3 - 6 cm	30 lbs 14 kg
K65	64065	6-1/2" 17 cm	7-1/2" 19 cm	3-3/4" 10 cm	1/8" - 2-1/2" .3 - 6 cm	41 lbs 19 kg

## Professional Reversible Mechanic's Vises

*Tornillos de banco reversibles para mecánicos profesionales*

*Étaux professionnels réversibles de mécanicien*

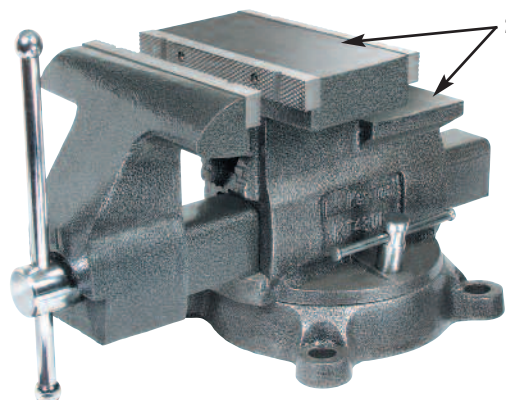

2 Built-in anvils provide more work surface area than any other vise

KT4800 8"

With our Reversible Vises you get all of the high quality features and rugged durability of the Pro Workshop Vises, and more! Significantly increase your gripping capacity when you reverse the position of the front jaw.

Model	Item No.	Jaw Width	Jaw Opening	Throat Depth	Pipe Jaw Capacity	Weight
KT4650	64650	6-1/2" 17 cm	7" - 10" 18 - 25 cm	3-3/4" 9.5 cm	1/8" - 3" .3 - 8 cm	50 lbs 23 kg
KT4800	64800	8" 20 cm	8 - 11" 20 - 28 cm	4-3/4" 12 cm	1/8" - 3" .3 - 8 cm	74 lbs 34 kg

## Professional C-Clamps

*Abrazaderas en C profesionales*

*Serre-joints en C professionnels*

This c-clamp is for the professional. Designed for strength and toughness, with sliding pin handle and acme-thread screw. Imported.



Model	Item No.	Jaw Opening	Jaw Depth	Screw Diameter	Std. Pack	Weight
KT-4	39604	4" 10 cm	2-1/16" 5 cm	5/8" 1.5 cm	6	1.8 lbs .8 kg
KT-6	39606	6" 15 cm	2-3/4" 7 cm	5/8" 1.5 cm	6	2.5 lbs 1.1 kg
KT-8	39608	8" 20 cm	3-1/4" 8 cm	3/4" 2 cm	1	3.5 lbs 1.6 kg

# Vises

**PROFESSIONAL VISES & C-CLAMPS**

**TORNILLOS DE BANCO PROFESIONALES  
Y PRENSAS C**

**ÉTAUX PROFESSIONNELS ET  
SERRE-JOINTS EN C**

## Increase Your Gripping Capacity

**2 VISE STYLES FOR THE  
PROFESSIONAL:**

**PRO WORKSHOP**

**PRO REVERSIBLE MECHANIC'S**





**Serpent™**

## Serpent™ Demount Tool

*Herramienta de desmontaje*  
*Outil de démontage*

*"Makes demounting easier than ever."*

Demounts **both** beads on most truck tires without the need for lifting the tire/wheel assembly off the ground, and then dropping it. Made of heat-treated alloy steel for maximum durability and strength.

- Length: 39" (99 cm)
- Stock: 3/4" (19mm)
- Patented

Model	Item No.	Weight
T2001	35449	6.5 lbs (3 kg)



Use to de-  
mount  
first bead

Use to demount  
second bead

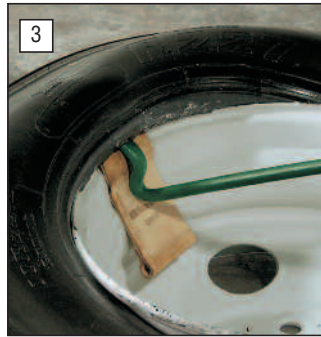

## Serpent™ Mount Tool

*Herramienta para montar*  
*Outil d'assemblage*



*"Makes mounting easier than ever."*

Designed to stop against the rim, and then remove itself effortlessly from between the rim and bead. The small end of the tool easily gets under the stretched bead for that last pull.

- Length: 38" (96 cm)
- Stock: 11/16" (17.5mm)
- Patented

Model	Item No.	Weight
T2002	35450	4 lbs (1.8 kg)

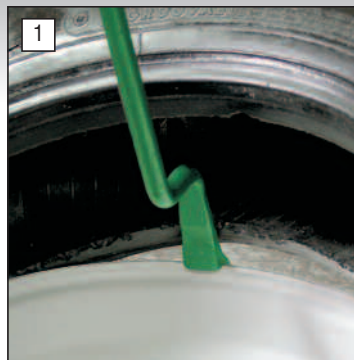



## Serpent™ 4 Pc. Tire Changing Set

*Juego de 4 piezas para cambiar llantas*

*Ensemble 4 pièces de changement de pneu*

*Take the struggle out of mounting  
and demounting truck tires...  
Everything you need to change tires  
easily and effortlessly:*

**Set No. 35453**

Weight: 12 Lbs. (5.4 kg)

### **T2001 (35449) Demount Tool**

- Demounts both beads
- No more lifting the tire/wheel assembly off the ground

### **T2002 (35450) Mount Bar**

- Designed to stop against the rim
- Won't slip into wheel well
- Small end of tool easily gets under the stretched bead for that last pull

### **31710 Bead Holding Device**

- Holds the bead in place against the wheel while mounting a tire

### **31810 Wheel Protector**

- Protects wheel rims from damage
- Patented



**Bead Holding Device**  
31710 Imported.  
(see page 36)



**Wheel Protector**  
31810  
(see page 36)



**Demount Tool**  
T2001 (35449)

**Mount Tool**  
T2002 (35450)



**TIRE CHANGING SETS**  
**JUEGOS PARA CAMBIAR LLANTAS**  
**ENSEMBLES DE CHANGEMENT DE PNEU**

**Simple,  
Easy,  
Quick!**

*Revolutionary new designs  
take the struggle out of  
mounting and demounting  
truck tires*

**UNIQUE MOUNT &  
DEMOUNT TOOLS:**

**SERPENT TOOLS**

**SUPER SERPENT TOOLS**

**SERPENT TOOL SETS**

*Ken-Tool offers a complete line of  
mount / demount tire irons  
~ see pages 35, 36, 37 ~*

# SUPER Tires Need SUPER Tools!

Finally! Tools specially designed to handle big, big tires that actually work! Now, mounting and demounting the biggest, heaviest truck tire is made easy. Our tools don't have to be super big and heavy to handle the tires that are.

These powerful tools are single-piece constructions, forged from high-grade carbon steel, and fully heat-treated for strength and long-lasting durability. We've even modified the bead holders, to "reach over" the extra wide band, and guide it under the rim.

## Super Serpent™ Mount Tool

*Herramienta para montar  
Outil d'assemblage*

This mount tool for super singles only weighs about 6-1/2 pounds. It may seem "funny-looking", but every inch of this innovative design is purely serious. It makes interference of the second bead, while mounting the first, a thing of the past, and delivers **twice** the leverage of **any** "straight-type" tire mounting tool. It even has the small end that easily gets under the bead for that "last pull".

- Length: 37" (94 cm)
- Stock: 3/4" (19 mm)

Model	Item No.	Weight
T2005	35447	6.6 lbs. (3 kg)

Patented

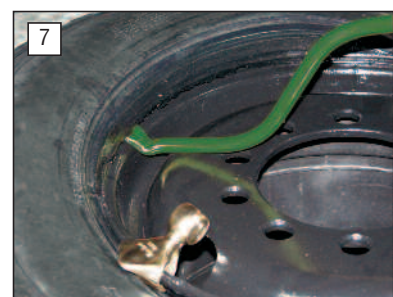
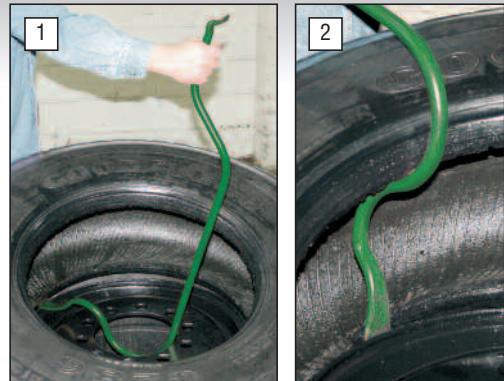

# Super Serpent™ 5 Pc. Tire Changing Set

*Juego de 5 piezas para cambiar llantas*

*Ensemble 5 pièces de changement de pneu*

Set No. 35446

Weight: 19 Lbs. (8.6 kg)



2 Bead Holding Devices  
31710 Imported.  
(see page 36)

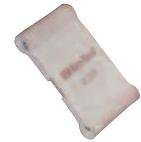

Wheel Protector  
31810  
(see page 36)



## Super Serpent™ Demount Tool

*Herramienta de  
desmontaje*

*Outil de démontage*

Weighing in at only 5-1/2 pounds, this unique, lightweight demount tool for super singles can be lugged around on a fingertip, yet delivers the incredible leverage, right where it's needed, to easily pop those heavyweights right off their wheels.

- Length: 37" (94 cm)
- Stock: 3/4" (19 mm)



Model	Item No.	Weight
T2006	35448	5.5 lbs (2.5 kg)

Patented

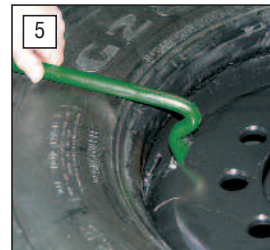
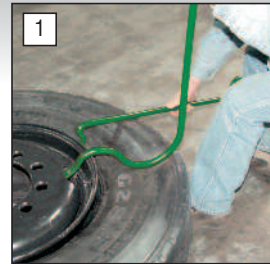
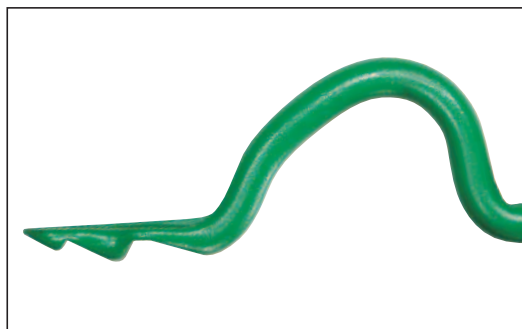



## Four-Way Lug Wrenches

*Llaves cruz*

*Clés à goujon à quatre têtes*

Ken-Tool offers the world's largest selection of quality lug wrenches, available in sizes to fit all your tire changing needs - SAE and Metric.

### Professional Lug Wrenches

*Llaves profesionales*

*Clés à goujon professionnelles*



T57  
"Our Best"

These wrenches are America's premier professional lug wrenches for cars, light trucks, SUV's, RV's, and vans. Drop-forged centers for extra strength. Keep wrenches in trunk for emergencies or everyday use.

Model	Item No.	Description	Socket Sizes	Length	Stock	Weight
T56	35656	Passenger	17, 19, 21, 22 mm	23" 58 cm	5/8" 16 mm	4 lbs 1.8 kg
T57®	35657	Passenger	3/4", 13/16", 7/8", 15/16"	23" 58 cm	5/8" 16 mm	4.5 lbs 2.0 kg

### Standard Lug Wrenches

*Llaves estándar*

*Clés à goujon standard*

Welded center construction for strength and durability. Premium grade, special bar quality steel for extra strength.

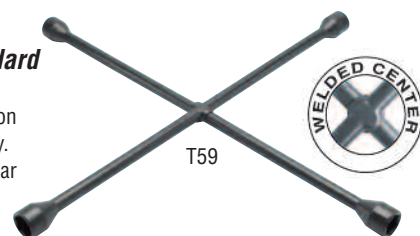

T59

Model	Item No.	Description	Socket Sizes	Length	Stock	Weight
T59	35659	Passenger	3/4", 13/16", 7/8", 15/16"	22" 56 cm	5/8" 16 mm	4.2 lbs 1.9 kg
T90	35690	Light Truck	7/8" deep well, 15/16", 1", 1-1/16"	25" 64 cm	3/4" 19 mm	7.2 lbs 3.2 kg

### Economy Lug Wrenches

*Llaves económicas*

*Clés à goujon économiques*

These wrenches have fully welded centers which stand up to everyday use.

3/4" SAE is also 19 mm.

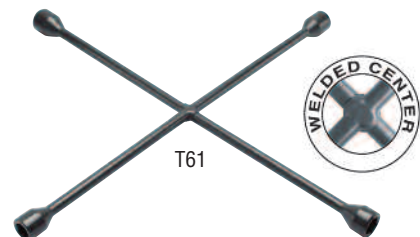

T61

Model	Item No.	Description	Socket Sizes	Length	Stock	Weight
T9520	35620	Passenger	3/4", 13/16", 7/8", 17 mm	20" 51 cm	9/16" 14 mm	3.4 lbs 1.5 kg
T61	35661	Passenger	3/4", 13/16", 7/8", 17 mm	22" 56 cm	9/16" 14 mm	3.8 lbs 1.7 kg
T62	35662	Passenger	3/4", 13/16", 7/8", 17 mm	18" 46 cm	9/16" 14 mm	3.2 lbs 1.5 kg
T63	35663	Passenger	17, 19, 21, 22 mm	18" 46 cm	9/16" 14 mm	3.2 lbs 1.5 kg

## Heavy-Duty Truck Lug Wrenches

*Llaves para camiones de alta resistencia*

*Clés à goujon pour camions lourds*

Use on heavy-duty trucks, buses, and tractors. Drop-forged or welded center provides strength and durability. **T95**, **TM95**, **T95A**, and **TC95** wrenches have center hole for a leverage bar. Socket sizes provided fit most metric or SAE lug nuts on today's trucks. Stock: 1" (25 mm).



T95  
"Our Best"

Model	Item No.	Socket Sizes	Length	Weight
T95	35695	1-1/16", 1-1/4", 1-1/2", 13/16" square	27-1/2" 70 cm	13.8 lbs 6.2 kg
TM95	35795	24, 27, 30, 33 mm	27-1/2" 70 cm	13.5 lbs 6.1 kg

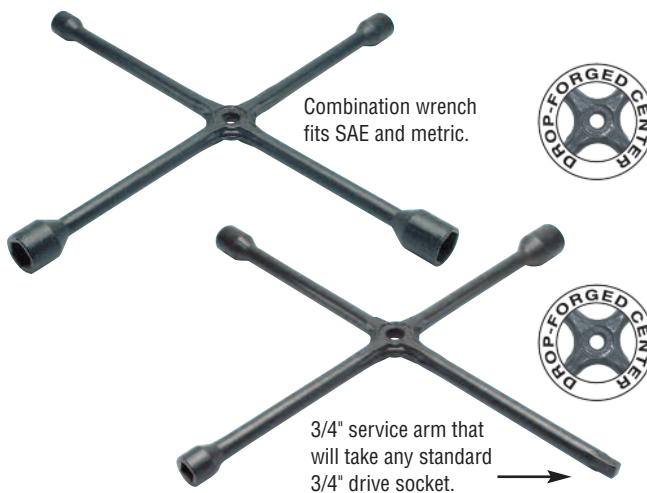

Combination wrench fits SAE and metric.

3/4" service arm that will take any standard 3/4" drive socket. →

Model	Item No.	Socket Sizes	Length	Weight
TC95	35595	1-1/2", 13/16" square, 30, 33 mm	27-1/2" 70 cm	14.2 lbs 6.4 kg
T95A	35697	1-1/4", 1-1/2", 13/16" sq., 3/4" service arm	27-1/2" 70 cm	13.5 lbs 6.1 kg



Model	Item No.	Socket Sizes	Length	Weight
T96	35696	1-1/16", 1-1/4", 1-1/2", 13/16" square	27-1/2" 70 cm	13.5 lbs 6.1 kg

## Economy Four-Way Lug Wrenches for the Do-It-Yourselfer

*Llaves cruz económicas para aficionados*  
*Clés à goujon à quatre têtes économiques pour le bricoleur*

A complete line of lug wrenches value priced and merchandised to maximize your DIY business... And they're all tough and dependable

### Passenger Car *Vehículo de pasajeros* *Automobile*

Chrome-plated finish, welded center. **Imported.**



Model	Item No.	Socket Sizes	Length	Stock	Weight
35630	35630	17 mm, 19 mm (3/4"), 21 mm (13/16"), 23 mm (7/8")	20"	5/8"	3.7 lbs
35635	35635	17 mm, 19 mm (3/4"), 21 mm (13/16"), 23 mm (7/8")	14"	5/8"	2.6 lbs
			36 cm	16 mm	1.2 kg

### Folding Passenger Car *Vehículo de pasajeros con* *asientos plegables* *Voiture automobile, pliable*

Chrome-plated finish. **Imported.**

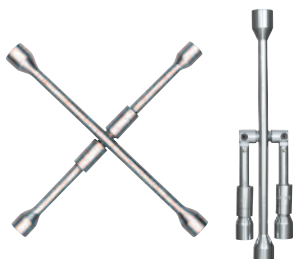

Model	Item No.	Socket Sizes	Length	Stock	Weight
35633	35633	17 mm, 19 mm (3/4"), 21 mm (13/16"), 23 mm (7/8")	14"	9/16"	2.7 lbs
			36 cm	14 mm	1.2 kg

### Telescoping Passenger Car *Automóvil de pasajeros* *con asientos extensibles* *Voiture automobile,* *téléscopique*

Chrome-plated finish. **Imported.**

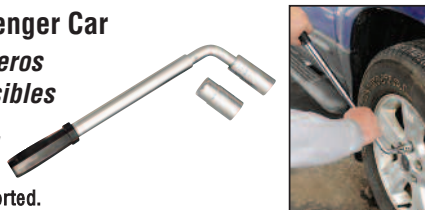

Model	Item No.	Socket Sizes	Length	Stock	Weight
35634	35634	17 mm, 19 mm (3/4"), 21 mm (13/16"), 23 mm (7/8")	21"(Extended) 53 cm	3 lbs	1.4 kg

### Passenger Car *Vehículo de* *pasajeros* *Automobile*

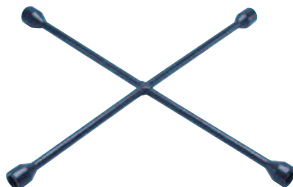

Painted finish, welded center.

Model	Item No.	Socket Sizes	Length	Stock	Weight
35637	35637	17 mm, 19 mm (3/4"), 21 mm (13/16"), 22 mm (7/8")	18"	9/16"	3.6 lbs
			46 cm	14 mm	1.6 kg

### Light Truck/RV *Camión liviano/* *vehículo de* *recreación* *Camionnette/VR*

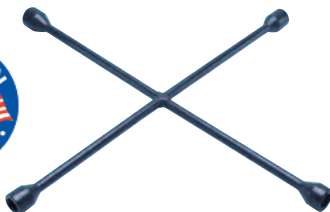

Painted finish, welded center.

Model	Item No.	Socket Sizes	Length	Stock	Weight
35638	35638	22 mm (7/8"), 24 mm (15/16"), 25 mm (1"), 27 mm (1-1/16")	23"	11/16"	5.6 lbs
			58 cm	17.5 mm	2.5 kg

## Double-End Truck Wrenches

*Llaves dobles para camiones*  
*Clés à double tête pour camions*



Use on trucks, buses, farm, and off-road vehicles. Great for on-the-road service. Sizes available for all SAE and metric lug nuts. All wrenches are forged from 1" alloy steel for long lasting strength. Length: 16" (41 cm). Use **TR5** truck wrench handle.

### SAE • SOCIEDAD DE INGENIEROS AUTOMOTRICES (SAE)

Model	Item No.	Sockets Sizes	Weight
TR1	32501	1-1/8" with 13/16" Sq. x 1-1/2"	4.6 lbs (2.0 kg)
TR2	32502	1" with 5/8" Sq. x 1-1/4"	4.3 lbs (1.9 kg)
TR3	32503	7/8" x 1-1/16"	4.5 lbs (2.0 kg)
TR3A	32505	1-1/16" x 1-1/8"	4.5 lbs (2.0 kg)
TR3X	32506	1-1/16" x 1-3/16"	4.5 lbs (2.0 kg)
TR98	32508	1-1/2" x 13/16" Sq.	4.5 lbs (2.0 kg)
TR9	32509	1-1/4" x 1-1/16"	4.4 lbs (2.0 kg)
<b>NEW</b> TR2A	32512	1" with 5/8" sq X 1-3/16"	4.5 lbs (2.0 kg)

### METRIC • MÉTRICO • MÉTRIQUE

Model	Item No.	Sockets Sizes	Weight
⊗ TRM1	32551	17 mm sq. x 35 mm	4.5 lbs (2.0 kg)
TRM2	32552	24 mm x 33 mm	4.4 lbs (2.0 kg)
TRM3	32553	27 mm x 30 mm	4.5 lbs (2.0 kg)
TRM6	32556	21 mm sq. x 41 mm	4.5 lbs (2.0 kg)
TRM7	32557	30 mm x 33 mm	4.5 lbs (2.0 kg)
<b>NEW</b> TRM6A	32559	33mm with 21mm sq X 41mm	4.5 lbs (2.0 kg)

⊗ OBSOLETE

### SAE / METRIC

Model	Item No.	Sockets Sizes	Weight
<b>NEW</b> TR99	32519	33mm with 13/16" sq X 1-1/2"	4.5 lbs (2.0 kg)

## Truck Wrench Handle

*Mango de llave para camiones*  
*Manche de clé pour camions*



Heat-treated for strength and durability.  
Fits all Ken-Tool Double-end truck wrenches

Model	Item No.	Length	Stock	Weight
TR5	32318	22" (56 cm)	3/4" Hex	2.7 lbs (1.2 kg)

## Heavy-Duty Truck Wrench

*Llaves para camiones de alta resistencia*  
*Clé robuste pour camions*



Use for off-the-road Budd-type wheels. Use **TR11** handle.  
Long length provides extra leverage. Stock: 1-1/4" (3.1 cm)

Model	Item No.	Length	Socket Size	Weight
TR10	34401	29-1/2" (75 cm)	1-3/4" Hex & 15/16" sq.	12.2 lbs (5.5 kg)
TR11	34402	30" (76 cm)		6.5 lbs (2.9 kg)

## Wrench Support Stand *Base de soporte para llave* *Support de soutien pour clé*



Commercial-duty stand used to support a double-end truck wrench, a 4-way lug wrench, or a torque wrench, when removing or replacing lug nuts. Adjusts from 14-1/2" to 22-1/2" high.



Model	Item No.	Weight
32610	32610	5.5 lbs (2.5 kg)

## Power Wrench

Llave eléctrica  
Clé à chocs



TR44SW Set

Designed for dual nut systems. Has 13/16" sq. end to hold inner nut, with a 1-1/2" hex drive to spin outer nut off. Also adaptable to remove any nut size with a **TR55** adapter. 3-to-1 ratio provides mechanical power advantage necessary to remove any stubborn nut found on trucks, farm vehicles, buses, aircraft, and RV's. Tremendous power allows one man operation. Heat-treated portable components for extra strength. All sockets are 3/4" drive.



### TR43 (34543) Basic Power Wrench Set

Juego de llaves eléctricas básicas

Jeu de clés à chocs de base

Weight: 19 lbs. (8.6 kg)

Set contains:

**Power Drive**

**TR45 (34543-02)** 20-1/2" (52 cm) Bar Handle.

**TR46 (34543-03)** 20" (51 cm) Tube Handle.

### TR44X (34545) Budd-Wheel Power Wrench Set

Juego de llaves eléctricas para ruedas tipo Budd

Jeu de clés à chocs pour roues à disque

The 3/4" service adapter allows you to use any 3/4" drive socket.

Drive end is 1-1/2" hex. 13/16" square adapter for inner nut.

Weight: 20 lbs. (9.1 kg)

Set contains:

**Power Drive**

**TR45 (34543-02)** 20-1/2" (52 cm) Bar Handle.

**TR52 (34543-15)** 3/16" Sq. Adapter

**TR53 (34543-16)** 36" (91 cm) Tube Handle.

**TR55 (34543-17)** 3/4" Service Adapter

### TR44SW (34547) Universal Power Wrench Set

Juego de llaves eléctricas universales

Jeu de clés à chocs universelles

Weight: 29 lbs. (13.2 kg)

Set contains:

**Power Drive**

**TR45 (34543-02)** 20-1/2" (52 cm) Bar Handle.

**TR53 (34543-16)** 36" (91 cm) Tube Handle.

**TR52 (34543-15)** 13/16" Square Adapter

**TR55 (34543-17)** 3/4" Service Adapter

**Impact sockets:**

**S20 (30128)** 7/8"      **S24 (30136)** 1-1/8"

**S21 (30130)** 15/16"    **S25 (30138)** 1-3/16"

**S23 (30134)** 1-1/16"   **S33 (30133)** 33 mm

## Dual Wheel Lug Stud Remover

Desmontador de tuercas para  
ruedas dobles

Extracteur de goujons de roues  
de camions à prise double

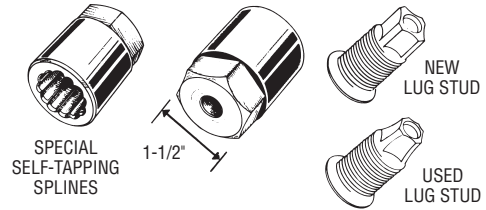
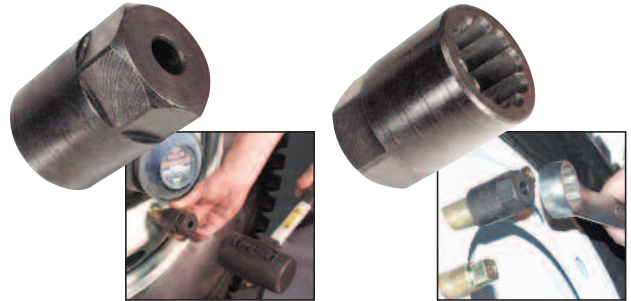

Special self-tapping splines provide maximum grip to remove stripped lug studs. Use with **TR1**, **TR98** truck wrenches. Can also be used with an open end wrench. Use with soft faced hammer.(see pg. 39)

Model	Item No.	Description	Weight
30165	30165	Fits 13/16" sq. inner nut	1 lb (.5 kg)

### No-Mar Rim Guard™

Tapa para llantas No-Mar

Protection de jante antimarque

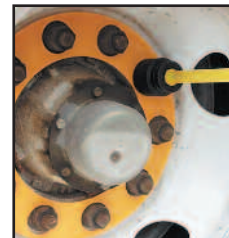
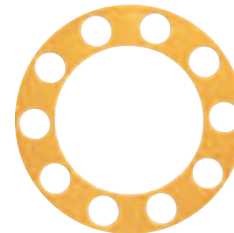

Protective cover prevents damage to chrome and aluminum rims and wheels when removing or replacing lug nuts. Imprinted with torque sequence number for proper torquing of disc wheels. **Imported from Canada.**

Model	Item No.	Description	Weight
30605	30605	Protective plastic cover	.5 lbs (.2 kg)

**Have a new idea?**  
**E-mail sales@kentool.com**

## Cap Nut Wrenches

*Llaves de tuercas ciegas*

*Clés à écrou borgne*

**Ken-Tool Porkchop™**



Wrenches hold outer cap nut on dual wheels while the inner nut is turned. Lip fits in hole to secure wrench in place. Sizes offered fit standard and metric cap nuts.

Model	Item No.	Description	Size	Weight
TX9®	30609	SAE	1-1/2"	.73 lbs (.3 kg)
TX10	30610	Metric	35 mm	.4 lbs (.1 kg)
TX12	30612	Metric	41 mm	.4 lbs (.1 kg)

## Combination Cap Nut Wrench

*Llave de tuercas ciegas de combinación*

*Clé à écrou borgne deux en un*



Offers the versatility of two wrenches in one unique product design. Fit one end onto the outer cap nut with the other end through the center hole. Wrench slides underneath center disc of wheel, reducing slipping during nut removal.

Model	Item No.	Description	Size	Weight
TX50	30620	SAE & Metric	41 mm, 1-1/2"	1.3 lbs (1.0 kg)

## Heavy-Duty Cap Nut Wrenches

*Llaves de tuercas ciegas de alta resistencia*

*Clés robustes à écrou borgne*



U.S. Patent  
no. D446,429



Heavy-duty design will not slip out of position. Wrench rests snugly against the center hole, reducing the possibility of rim damage. Ideal for aluminum wheels.

Model	Item No.	Description	Size	Weight
TX200	30618	SAE	1-1/2"	2.6 lbs (1.2 kg)
TX241	30619	Metric	41 mm	2.6 lbs (1.2 kg)



## Wheel Cover Puller / Replacers

*Extractor/cambiadores de cubiertas*

*Extracteur de garde-roues/garde-roues d'échange*

Removes wheel covers quickly and easily without gouging or scratching them. Rubber head **T11RH** prevents damage to hub cap and is replaceable.

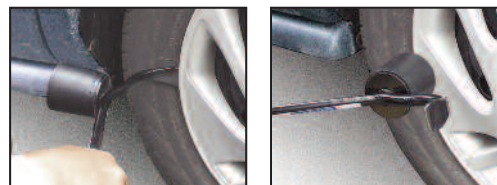

**Pro**  
*Profesional*  
*Professionnel*



Model	Item No.	Length	Stock	Weight
T67	31567	17-1/2" (45 cm)	9/16" (14.3 mm)	1.8 lbs (.8 kg)

**Standard**  
*Estándar*  
*Standard*



Model	Item No.	Length	Stock	Weight
T68®	31568	14" (36 cm)	7/16" (11.1 mm)	1.3 lbs (.6 kg)

## Center Cap Removers

*Desmontadores de tapas centrales*

*Extracteur de chapeau centrale*

**Wide Blade**  
*Paleta ancha*  
*Lame large*



Removes larger center covers without damaging wheels.

Model	Item No.	Length	Stock	Weight
T65	31565	7-3/4" (19.6 cm)	5/16" (7.9 mm)	.2 lbs (.09 kg)

**Narrow Blade**  
*Paleta angosta*  
*Lame étroite*

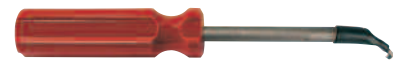

Removes small delicate center covers without wheel damage.

Model	Item No.	Length	Stock	Weight
T66	31566	7-3/4" (19.6 cm)	5/16" (7.9 mm)	.2 lbs (.09 kg)

## Two Piece Center Cap Remover Set

*Equipo de dos desmontadores de tapas centrales*

*Ensemble (2 pc) chapeau centrale de pneu*

Set consists of: No. T65 (31565), No. T66 (31566).

Model	Item No.	Description	Weight
31564	31564	2 Pc. Center Cap Remover Set	.5 lbs (.22 kg)



**TIRE SERVICE TOOLS & EQUIPMENT, & SPECIALTY TOOLS**  
**HERRAMIENTAS PARA REPARAR LLANTAS, EQUIPO Y HERRAMIENTAS ESPECIALIZADAS**  
**OUTILS D'ENTRETIEN DE PNEU, ÉQUIPEMENT ET OUTILS SPÉCIAUX**

**World Class Quality**

**A COMPLETE LINE OF TIRE CHANGING TOOLS:**  
**WRENCHES • BEAD BEAKERS**  
**LOCK RING TOOLS**  
**MOUNT / DEMOUNT TOOLS**  
**HAMMERS & HANDLES**  
**TIRE SERVICE TOOLS**  
**SOCKETS • INFLATION CAGES**  
**SMALL TIRE SERVICE TOOLS**  
**SHOP SERVICE TOOLS**

*Over 80 years dedication to research, manufacturing, customer service, & shipping excellence combine to give you the best made tire changing products in the world*

## Bead-Breaking Tools Truck / Farm / OTR

*Herramientas desmontadoras de llantas para camiones/vehículos de granja/de carretera*

*Outils de décollage des talons pour camions/tracteurs/véhicules tout terrain*



33341

These lightweight, portable tools are a great alternative to handled bead breaking wedges or hydraulic bead breakers. One end is used to remove frozen or rusted beads from all types of rims. On the T52, the other end can be used as a leverage bar when inserted into the 35695 or 35697 Truck Lug Wrench.

### Swan Neck Leverage Bar

*Palanca de cuello de cisne*

*Barre de levage à col de cygne*



Model	Item No.	Length	Stock	Weight
T41	33341	30" (76 cm)	7/8" (22 mm)	5.3 lbs (2.4 kg)

### 30" Bead Breaker

*Desmontadora de llantas de 30 pulgadas*

*Démonte-talons de 30 po*



Model	Item No.	Length	Stock	Weight
T42	33342	30" (76 cm)	7/8" (22 mm)	4.8 lbs (2.2 kg)

### Bead Breaker Leverage Bar

*Palanca desmontadora de llantas*

*Barre de levage pour démonte-talons*



Also for use with the T95 wrenches.

Model	Item No.	Length	Stock	Weight
T52	34652	33" (84 cm)	7/8" (22 mm)	5.5 lbs (2.5 kg)

## Portable Bead Breaker

*Desmontadora de llantas portátil*

*Démonte-talons portatif*



Portable bead-breakers are great for custom and foreign wheels. They break beads on most sizes of passenger tires and light trucks.

Model	Item No.	Handle Length	Weight
T100	34670	36" (91 cm)	5.2 lbs (2.3 kg)



## Bead-Breaking Tool / Driving Iron

*Herramienta desmontadora de llantas/barra de hierro desmontadora*

*Outil de décollage des talons/Levier d'entraînement*



Driving iron is used for loosening rusted truck and bus beads. Will speed truck tire repair work and save labor and time.



Model	Item No.	Length	Stock	Weight
T26A	32126	11-3/4" (30 cm)	1-1/4" (32 mm)	4.4 lbs (2.0 kg)

## Impact Bead Breakers

*Desmontadoras de llantas de impacto*  
*Démonte-talons à chocs*

Bead breaker loosens beads with bead-breaking foot and ram bar, but never cuts the bead of the tire. The wedge foot is forced between the bead and rim flange. Breaker is designed for shop or road use. No other bead breaking tools are necessary. Provides greater accuracy than other conventional bead breakers.



**T26B** has exclusive spring action design to reduce user fatigue associated with slide hammer kickback.

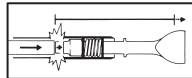

Model	Item No.	Description	Length	Length Extended	Weight
T26B	35926	Heavy-duty	50" 127 cm	80" 203 cm	23 lbs 10.4 kg



Model	Item No.	Description	Length	Length Extended	Weight
T24B	35924	Economy	46" 117 cm	72" 183 cm	13.5 lbs 6.1 kg

## Floor Type Bead Breakers

*Desmontadoras de llantas con pie*  
*Démonte-talons sur sol*

Ideal for stubborn tires. Use to prevent the bending of wheels. A great solution for custom and foreign wheels.



Model	Item No.	Description	Tread Width	Weight
T98	35998	Deluxe	up to 11" (28 cm)	29.8 lbs (13.5 kg)

**Ken-Tool**  
*WHEREVER TIRES ARE CHANGED™*

## Lock Ring Tools

*Herramientas para anillos de seguridad*

*Outils pour anneau verrouilleur*



These tools are designed to remove most truck lock rings. A must-have for anyone mounting or demounting multi-piece rims. Use in pairs.

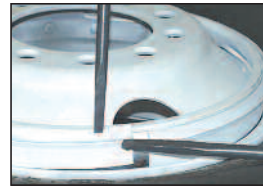

### Truck Lock Ring Remover

*Desmontador para anillos de seguridad para camiones*  
*Dégageur d'anneau verrouilleur pour camions*



Designed for smaller diameter wheels.

Model	Item No.	Length	Stock	Weight
T23 <sup>®</sup>	32123	24" (61 cm)	11/16" (17.5 mm)	2.4 lbs (1.0 kg)

### Truck Lock Ring Remover

*Desmontador para anillos de seguridad para camiones*  
*Dégageur d'anneau verrouilleur pour camions*



Designed for smaller diameter wheels.

Model	Item No.	Length	Stock	Weight
T23A <sup>®</sup>	33223	30" (76 cm)	11/16" (17.5 mm)	3.1 lbs (1.4 kg)

### Combination Rim / Ring Tool

*Herramienta para combinación de llantas/anillos*  
*Deux en un pour jante/anneau*



Flat tapered end ideal for all around ring and rim work.

Model	Item No.	Length	Stock	Weight
T23B	33224	23-1/2" (60 cm)	11/16" (17.5 mm)	2.4 lbs (1.0 kg)

### Rim Lock Tool

*Herramienta para anillos de seguridad de llantas*  
*Bloque-talons*



For servicing wide base rims.

Model	Item No.	Length	Stock	Weight
T25	32125	18" (46 cm)	11/16" (17.5 mm)	1.8 lbs (.8 kg)

### Special Lock Ring Tool

*Herramienta para anillos de seguridad especiales*  
*Outil spécial pour anneau verrouilleur*



Long tapered curved end for continuous side rings.

Model	Item No.	Length	Stock	Weight
T27	32127	18" (46 cm)	11/16" (17.5 mm)	1.8 lbs (.8 kg)

**Lock Ring Tool****Herramienta para anillos de seguridad****Outil pour anneau verrouilleur**

Removes continuous side rings on two-piece truck rims.



Model	Item No.	Length	Stock	Weight
T27A	32128	18" (46 cm)	11/16" (17.5 mm)	1.8 lbs (.8 kg)

**Heavy-Duty Lock Ring Tool****Herramienta para anillos de seguridad de alta resistencia****Outil robuste pour anneau verrouilleur**

Use for multi-piece wheels, especially hub type.

Model	Item No.	Length	Stock	Weight
T48A	34648	37" (94 cm)	3/4" (19 mm)	4.6 lbs (2.1 kg)

**Small Tire Mount/Demount Irons****Barras para montaje/desmontaje de llantas pequeñas****Leviers de montage/démontage de petits pneus**

New designs are based on popular European styles. Extended length of the flat curved sliding surface provides mounting ability comparable to much longer traditional tire irons. Sizes available for motorcycle, passenger, truck, and heavy-duty tires. Designed for mounting and demounting tires. Best if used in pairs.

**Motorcycle / Small Wheel****Ruedas pequeñas/de motocicleta****Motocyclette / Petites roues**

Model	Item No.	Length	Stock	Weight
T43A	39805	15" (38 cm)	3/4" (19 mm)	1.8 lbs (.8 kg)

**Mount / Demount Tire Tools - Small Tire****Herramientas para montaje y desmontaje de llantas - Llantas pequeñas****Outils de montage/démontage de pneus - Petits pneus**

Tools are used in pairs to mount or demount small passenger, industrial, ATV, and motorcycle tires.



Model	Item No.	Length	Stock	Weight
T6A	32106	16-1/2" (42 cm)	5/8" (16 mm)	1.5 lbs (.7 kg)

**Tire Irons - Small Tire****Barras para llantas - Llantas pequeñas****Démonte-pneus - Petits pneus**

Pro tire changing tools for small tires. Ideal for mounting and demounting motorcycle, ATV, lawn tractor, golf cart, and small tires by hand. Rounded ends will not pinch tube. Patented.

Model	Item No.	Length	Stock	Weight
T9A	32109	9" (23 cm)	7/16" (11 mm)	.4 lbs (.16 kg)
T16A	32116	16" (41 cm)	7/16" (11 mm)	.7 lbs (.3 kg)
T9C	32110	2 pc. Carded Set - Contains 2 T9A 9" Bars		
T16C	32117	2 pc. Carded Set - Contains 2 T16A 16" Bars		

**Tire Irons - Small Tire****Barras para llantas - Llantas pequeñas****Démonte-pneus - Petits pneus**

Pro tire changing tools for small tires. Sturdy, comfortable plastic handles. Ideal for mounting and demounting motorcycle, ATV, lawn tractor, golf cart, and small tires by hand. Rounded ends will not pinch tube.

Model	Item No.	Length	Stock	Weight
T5	32115	16" (41 cm)	7/16" (11 mm)	.8 lbs (.36 kg)
T8	32118	16" (41 cm)	7/16" (11 mm)	.8 lbs (.36 kg)

**Two Piece Small Tire Iron Set****Equipo de dos barras para llantas pequeñas****Ensemble petit barre à pneu (2 pcs)**

Set consists of: No. T5 (32115), No. T8 (32118).

Model	Item No.	Description	Weight
32114	32114	2 Pc. Small Tire Iron Set	1.6 lbs (.7 kg)



**Ken-Tool®**  
WHEREVER TIRES ARE CHANGED™

## European Style Tools

*Herramientas de estilo europeo*

*Outils de style européen*



Use on car, motorcycle, truck, and agricultural tires.  
Designed for mounting and demounting tires.  
Best if used in pairs.



Model	Item No.	Length	Stock	Weight
T43C	39806	21" (53 cm)	7/8" (22 mm)	3.1 lbs (1.4 kg)



Model	Item No.	Length	Stock	Weight
T43D	39810	30" (76 cm)	7/8" (22 mm)	4.5 lbs (2.0 kg)



Model	Item No.	Length	Stock	Weight
T44	39808	31" (79 cm)	7/8" (22 mm)	5.3 lbs (2.4 kg)

T44 illustration

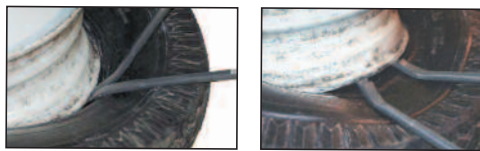

Cross Reference:

Ken-Tool No.	T43A	T43C	T43D	T44	T45SX	T45DX	T41
CPM	Livraison Ref. 1547	Face 68 Ref. 426/68	Force Ref. 1289	Halte Ref. 1060	Hyoca Ref. 1194	Hyude Ref. 1195	Sayam Ref. 858

## Tire Mount / Demount Spoons

*Espátula para montaje/desmontaje de llantas*

*Cuillères de montage/démontage de pneus*

These tools are designed for fast and efficient tire changing. Use the 18" and 24" spoons to mount or demount passenger car, motorcycle, ATV, and light truck tires. The 30" spoons provide enough strength and leverage to work on large truck, bus, off-road vehicle, tractor, and aircraft tires.

Mount



Demount



### Straight • Recta • Droit

Model	Item No.	Length	Stock	Weight
T1X	32101	18" (46 cm)	11/16" (17.5 mm)	1.8 lbs (.8 kg)
T19	32119	24" (61 cm)	11/16" (17.5 mm)	2.5 lbs (1.1 kg)
T19A	33219	30" (76 cm)	11/16" (17.5 mm)	3 lbs (1.4 kg)
T38	33238	30" (76 cm)	7/8" (22 mm)	4.8 lbs (2.2 kg)



### Drop-Center • Con base con caída • A centre base

Model	Item No.	Length	Stock	Weight
T21R	32121	18" (46 cm)	11/16" (17.5 mm)	1.8 lbs (.8 kg)
T21F	34121	24" (61 cm)	11/16" (17.5 mm)	2.5 lbs (1.1 kg)
T21HD	34122	30" (76 cm)	7/8" (22 mm)	4.5 lbs (2.0 kg)



### Curved • Curva • Cuvée

Model	Item No.	Length	Stock	Weight
T2X	32102	18" (46 cm)	11/16" (17.5 mm)	1.8 lbs (.8 kg)
T20	32120	24" (61 cm)	11/16" (17.5 mm)	2.4 lbs (1.1 kg)
T20A	33220	30" (76 cm)	11/16" (17.5 mm)	3.1 lbs (1.4 kg)
T39	33239	30" (76 cm)	7/8" (22 mm)	4.5 lbs (2.0 kg)

See more single-end spoons on Page 11

## Tubeless Tire Irons & Sets

*Juegos y barras para llantas sin cámara*

*Démonte-pneus individuels & en ensemble pour pneus sans chambre à air*



T46A, T47A



T46B, T47B



T46C, T47C



T47A end

Sets provide all irons necessary for a variety of tire changing applications. Use "C" bar with the "B" extension bar for easier use on large, wide-base truck tires. Use on standard and large truck tires, including industrial, farm, buses, and tractors.

### Standard • Estándar • Standard

Model	Item No.	Description	Length	Stock	Weight
T46	34746	<b>Tire Iron Set</b> includes: T46A, T46B, T46C		3/4" 19 mm	12 lbs 5.4 kg
T46A	34747	Straight Mount/Demount Tool	36" 91 cm	3/4" 19 mm	4.5 lbs 2.0 kg
T46B	34748	Straight Mount/Demount Tool "B" Extension for T46C	36" 91 cm	3/4" 19 mm	4.5 lbs 2.0 kg
T46C	34749	Offset Mount "C" Bar	22" 56 cm	3/4" 19 mm	3 lbs 1.4 kg

### Heavy-Duty • De alta resistencia • Robuste

Model	Item No.	Description	Length	Stock	Weight
T47	34846	<b>Tire Iron Set</b> includes: T47A, T47B, T47C		1" 25 mm	29 lbs 13.1 kg
T47A	34847	Straight Mount/Demount Tool	52" 132 cm	1" 25 mm	11 lbs 5.0 kg
T47B	34848	Straight Mount/Demount Tool "B" Extension for T47C	49-1/2" 126 cm	1" 25 mm	11 lbs 5.0 kg
T47C	34849	Offset Mount "C" Bar	27" 69 cm	1" 25 mm	6.6 lbs 3.0 kg

Mounting



Demounting



## Tubeless Truck Tire Mount / Demount Irons

*Barras para montaje/desmontaje de llantas de camiones sin cámara*

*Démonte-pneu de montage/démontage pour pneus de camion sans chambre à air*



Ken-Tool manufactures the largest and most diverse selection of tire mount/demount irons in the world. From the T45A® and T45AC Classic for standard truck tires, to the Serpent™ and Super

Serpent™ Tire Changing Systems for wide-base Super Singles, Ken-Tool makes a tire iron for all your tire changing needs. Use on truck, agricultural, and industrial tires. One-piece manufacturing process and design assures long life and superior performance. Heat-treated for strength. Use in pairs. T45A® is a registered trademark of Ken-Tool.

Mount



Mount



Demount



Demount



## Aluminum Wheel Protector

*Protector de cubiertas de aluminio*

*Protecteur pour roues en aluminium*



Protect expensive rims from damage during manual tire changing. Prevents tire tools from marring or scratching aluminum or steel rims when using Ken-Tool's manual tire changing tools. Durable leather protector fits on the rim and protects inside of the rim well. Use with an assortment of tire tools including: T45A® - style tire irons, Serpent™, tire spoons, other Ken-Tool tire changing tools. When one end wears out, flip it over and use the opposite end. Great for roadside service or in the shop. Patented.

Model	Item No.	Description	Weight
31810	31810	Leather	.35 lbs (.15 kg)

## Ken-Tool brings back an old favorite – T45AC Classic



Ken-Tool's patented designs offer one-piece construction, and assure long life for many tire-changing applications.

Tip ends insert easily and will not cut or rip bead or sidewall. These designs make it easier to mount and demount tires without changing the way the tool is used.



T45AC Classic

T45A



Mount end: Precision forged knob grips rim. New design won't slip during tire mounting. Special curve design always grabs the bead edge.



Demount end: Precision-forged angled tip slides between bead and rim easily. Forged design won't slip when demounting the second bead.

Model	Item No.	Length	Stock	Weight
T45A®	34645	37" (94 cm)	3/4" (19 mm)	4.6 lbs (2.1 kg)
T45AC	34645C	37" (94 cm)	3/4" (19 mm)	4.6 lbs (2.1 kg)
T45HD	34647	41" (104 cm)	7/8" (22 mm)	7 lbs (3.2 kg)
T47A	34847	52" (132 cm)	1" (25 mm)	11 lbs (5.0 kg)

## Standard T45A® Style Tubeless Tire Iron

*Barra para llanta sin cámara estilo T45A® estándar*

*Démonte-pneu standard style T45A® pour pneus sans chambre à air*



Design allows for less effort, provides excellent wheel/rim surface contact area for less side to side movement. Improved blade and knob design. Tip on one end for 'grabbing' the rim.

Model	Item No.	Length	Stock	Weight
T45A-2000K™	34644	37" (94 cm)	3/4" (19 mm)	5 lbs (2.2 kg)

## Bead Holding Device

*Dispositivo para soporte de llantas*

*Dispositif de retenue des talons*



**Now reaches over extra wide bead of super singles.**

Holds the bead in place against the wheel when mounting the tire on to the wheel. Do not use to pry. **Imported.**

Model	Item No.	Description	Weight
31710	31710	Solid Brass	1.8 lbs (.8 kg)

**For additional mount / demount tire irons see the Serpent Tire Changing Systems on pages 24-27**

# Tire Inflation Cages • Cajas para inflado de llantas • Cages de sécurité pour gonflement de pneus



Mandatory for any shop working with tubeless and multi-piece rims. Made from heavy-gauge steel tubing welded to a steel base. Guards against blown lock rings and rims. Follow OSHA regulation 29-CFR Part 1910.177. Read safety label on cage. Designed to meet OSHA regulation requirements for Medium, Heavy-Duty Truck, OTR, Tractor, and Super Singles. Ken-Tool offers sizes and designs for all your needs. For additional safety labels or instructions, call Ken-Tool customer service.

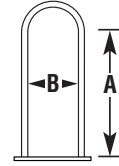

**Work safely.**  
**Always use an inflation cage when inflating tires.**  
**Follow OSHA regulation 29-CFR Part 1910.177 whenever changing tires.**

## Passenger and Light Truck Cage

*Jaula para camión liviano y para pasajeros*

*Cabine passager et véhicule utilitaire léger*

A must for run-flat, low-profile, and other tires that are difficult to seat.



Model	Item No.	Height A**	Width B	Base	Weight
T103	36003	30" 76 cm	16" 41 cm	21-1/2" x 22" 55 cm x 56 cm	80 lbs 36.2 kg

## Portable Wide Base Cage

*Caja con base amplia portátil*  
*Cage portative à base large*

Especially designed for wide base tires, this portable inflation cage will hold super singles, and super wide radial tires. Fits comparable tires up to: 455/55R 22.5 Wide Super Single.



Model	Item No.	Height A**	Width B	Base	Weight
T101A	36007	43-1/2" 111 cm	20-1/2" 52 cm	7" closed x 27" 18 cm closed x 69 cm	72 lbs 32.6 kg

## Portable 2-Bar Cage

*Caja de dos barras portátil • Cage portative à deux barres*

Model	Item No.	Height A**	Width B	Base	Weight
T101	36001	41" 104 cm	16" 41 cm	7" closed x 21-1/2" 18 cm closed x 55 cm	60 lbs 27.2 kg



## 3-Bar Cage

*Caja de 3 barras*  
*Cage à 3 barres*

Model	Item No.	Height A**	Width B	Base	Weight
T106	36006	43-1/2" 111 cm	20-1/2" 52 cm	26" x 22" 66 cm x 56 cm	134 lbs 60.7 kg

## 4-Bar Cage

*Caja de 4 barras*  
*Cage à 4 barres*

Model	Item No.	Height A**	Width B	Base	Weight
T102	36002	43-1/2" 111 cm	20-1/2" 52 cm	31-1/2" x 26" 80 cm x 66 cm	146 lbs 66.2 kg



## 5-Bar Cage

*Caja de 5 barras*  
*Cage à 5 barres*



Model	Item No.	Height A**	Width B	Base	Weight
T105	36005	43-1/2" 111 cm	20-1/2" 52 cm	41" x 26" 104 cm x 66 cm	182 lbs 82.5 kg



## 3-Bar Cage (OTR)

*Caja de 3 barras (de carretera)*  
*Cage à 3 barres (pneus tout terrain)*



Model	Item No.	Height A**	Width B	Base	Weight
T104	36004	65" 165 cm	24" 61 cm	30" x 27" 76 cm x 69 cm	158 lbs 72.6 kg

\*\* Height A refers to the approximate height to the inside bend of the cage.

**WARNING:** Tire changing can be dangerous, and should be done only by trained personnel using proper tools and equipment as directed by Federal OSHA Standard No. 29 CFR Part 1910.177. Tires may explode during inflation causing injury to operator or bystander. Wear safety goggles. Keep all parts of body outside cage. Use extension hose, clip-on chuck, and remote valve. See supervisor for safety procedures.

**WARNING:** Do not alter cage in any way. Cage must be freestanding and at least three feet from other objects. Discard cage if bent, cracked, or otherwise damaged. Always wear safety goggles.

## Truck Tire Changing Stand

*Soporte para cambio de llantas de camiones*  
*Support de démontage pour pneus de camions*



Stand handles wheels or open rims 16.5" to 24". Double-slide adjustment with locking device prevents twisting so it stays aligned with the wheel or rim. Stand is the ideal height for driving off beads or demounting tires. It must be used to be appreciated.

Model	Item No.	Weight
T115	36015	21 lbs (9.5 kg)

## Cross-Pein / Blacksmith Hammer

*Martillo de mano/de peña*  
*Marteau à panne de travers/de forgeron*

High carbon steel with machine polished face. **Imported.**



**Top Grade U.S. Hickory Handle**

*Mango U.S. Hickory de primera calidad*  
*Manche de qualité supérieure U.S. Hickory*

Model	EDP No.	Length	Face	Eye Size	Head Weight
85H-3	37103	16"	1-5/8"	1 x 1-3/4"	3 lbs (1.4 kg)

## New England Pattern Hand-Drilling Hammers

*Martillos perforadores de mano con patrones de Nueva Inglaterra*  
*Perforateur manuel modèle 'New England'*

Top grade U.S. hickory handle. **Imported.**



Model	EDP No.	Length	Face	Eye Size	Head Weight
80H-3	37003	10-1/2"	1-1/2"	1 x 3/4"	3 lbs (1.4 kg)
80H-4	37004	10-1/2"	1-5/8"	1 x 3/4"	4 lbs (1.8 kg)

## Tire Knockers

*Golpeadores de llantas*  
*Bâtons de vérification de pression des pneus*



Model	EDP No.	Length	Weight
35110	35110	18" (46 cm)	.7 lbs (.3 kg)

## Dead Blow Hammers

*Martillos de golpe seco • Masse sans rebond*

Head is shot filled for maximum force with no bounce effect. Safest non-marring, non-sparking hammers available. Great for tire changing and general shop use. High quality materials to withstand years of hard use.



**Economy Strike Pro®**

*Económico • Économique*

Dead blow action in high visibility colors.

T336

Model	EDP No.	Color	Length	Nominal Weight
T335	35335	Safety Yellow	12" (31 cm)	1 lb (.5 kg)
T336	35336	Safety Orange	12" (31 cm)	1.5 lbs (.7 kg)

**Professional Dead Blow**



*Martillo de golpe seco profesional*

TG337 Steel face

*Masse professionnelle sans rebond*

Power-drive fiberglass handle gives 20% more driving power, yet reduces user fatigue. One-pound dead blow hammer is especially useful for truck wheel weights.



Model	EDP No.	Description	Length	Nominal Weight
TG331	35331	1 lb Head (.5 kg)	12-1/4" (31 cm)	1.8 lbs (.8 kg)
TG332	35332	2 lb Head (.9 kg)	13-1/2" (34 cm)	1.9 lbs (.9 kg)
TG333	35333	3 lb Head (1.4 kg)	14-1/2" (37 cm)	2.7 lbs (1.2 kg)
TG334	35334	4 lb Head (1.8 kg)	15-1/2" (40 cm)	3.4 lbs (1.5 kg)
TG337	35337	Steel Face / Soft Face	13-1/2" (34 cm)	2.2 lbs (1.0 kg)

**WARNING:** Always wear safety goggles when using striking or struck tools. Never use one hammer to strike another hammer. Never use a tool with a loose or damaged handle. Discard any striking or struck tool if tool shows dents, cracks, chips, or mushrooming.

## Duck-Billed Bead Breaking Wedges

*Our most popular bead breakers.*

*Cuñas desmontadoras de llantas de boca plana*  
*Coins d'écartement de talons en bec de canard*



T11E®



**Wood Handled • Con mango de madera • Manche en bois**

Model	EDP No.	Handle No.	Length	Weight
T11D	35327	T11DH	17" (43 cm)	4.8 lbs (2.2 kg)
T11E®	35329	T11EH	30" (76 cm)	11 lbs (5 kg)

**Fiberglass Handled**

*Con mango de fibra de vidrio • Manche en fibre de verre*



TG11D

Model	EDP No.	Handle No.	Length	Weight
TG11D	35427	TG11DH	18" (46 cm)	4.8 lbs (2.2 kg)
TG11E	35429	TG11EH	32" (81 cm)	11 lbs (5 kg)

**Polymer Handled**

*Con mango de polímero*  
*Manche en polymère*

Hump Design prevents tool from wedging between rim and bead. Breaks the bead with little or no prying. New polymer handle design for longer lasting everyday use. Full length fiberglass core for greater strength. Coating on handle provides durability.

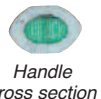

U.S. Patent no. 6,327,033

Handle cross section

Model	EDP No.	Replacement Handle	Length	Head Weight
T11K™	35460	T11KH (35230)*	32" (81 cm)	10.5 lbs (4.8 kg)

\*New handle design T11KH (35230) will not work with old style T11E head

## Double-Face Sledge Hammers

*Mazas dobles*

*Masses à double-face*



84H-4

High carbon steel, heat treated. Machined, polished face. **Imported.**

**Top Grade U.S. Hickory Handle**

*Mango U.S. Hickory de primera calidad*

*Manche de qualité supérieure U.S. Hickory*

Model	EDP No.	Length	Face	Eye Size	Head Weight
84H-2	37302	15"	1-1/2"	3/4" x 1"	2 lbs (.9 kg)
84H-4	37304	15"	1-3/4"	3/4" x 1"	4 lbs (1.8 kg)
84H-8	37308	32"	2"	1" x 1-3/8"	8 lbs (3.6 kg)
84H-10	37310	36"	2-1/8"	1" x 1-3/8"	10 lbs (4.5 kg)
84H-12	37312	36"	2-1/8"	1" x 1-3/8"	12 lbs (5.4 kg)
84H-16	37316	36"	2-3/8"	1" x 1-3/8"	16 lbs (7.2 kg)
84H-20	37320	36"	3"	2" x 1.5"	20 lbs (9.0 kg)

## 2 lb. Rubber Mallet

*Mazo de goma de 2 libras*

*Maillet en caoutchouc de 2 lb*



Rubber head minimizes marring surfaces.



Model	EDP No.	Handle Length	Head Weight
T32	35310	17"	2 lbs (.9 kg)



## General Purpose Tire Hammers • Martillos para llantas universales • Masse à tout usage

Designed for tire service in a variety of sizes and styles. Use rubber head replacement T11RH (35104).

### Wood Handled

Con mango de madera  
Manche en bois

Model	Item No.	Handle No.	Length	Weight
T11B	35311	T11BH	14-1/2" (37 cm)	4.5 lbs (2.0 kg)

Model	Item No.	Handle No.	Length	Weight
T33R	35317	T11HN	14" (36 cm)	2.3 lbs (1.0 kg)

### Fiberglass Handled

Con mango de fibra de vidrio  
Manche en fibre de verre

Model	Item No.	Handle No.	Length	Weight
TG11B	35411	TG11BH	16" (41 cm)	4.8 lbs (2.1 kg)

Model	Item No.	Handle No.	Length	Weight
TG33R	35417	TG31H	16" (41 cm)	2.5 lbs (1.1 kg)



## Heavy Duty Tire Hammers • Martillos para llantas de alta resistencia • Masses à pneu robuste

Hammers are used for mounting and demounting tires. They make tire changing faster and easier for passenger car, truck, bus, farm tractor, and aircraft tires. A variety of weights and sizes are offered to meet all your tire changing needs. Non-marring rubber end can be used for driving on lock rings. Use rubber head replacement T34RH (35105).

### Wood Handled

Con mango de madera  
Manche en bois

Model	Item No.	Handle No.	Length	Head Weight	Weight
T34	35321	T11CH	17"	4.8 lbs	5.4 lbs
			43 cm	2.2 kg	2.4 kg

Model	Item No.	Handle No.	Length	Head Weight	Weight
T35	35323	T11CH	16-1/2"	5.5 lbs	6.1 lbs
			42 cm	2.5 kg	2.7 kg

Model	EDP No.	Handle No.	Length	Head Weight	Weight
T36	35325	T11CH	16-1/2"	5.8 lbs	5.3 lbs
			42 cm	2.6 kg	2.4 kg

### Fiberglass Handled

Con mango de fibra de vidrio  
Manche en fibre de verre

Model	Item No.	Handle No.	Length	Head Weight	Weight
TG34	35421	TG11CH	18"	5.5 lbs	6 lbs
			46 cm	2.5 kg	2.7 kg

Model	Item No.	Handle No.	Length	Head Weight	Weight
TG35	35423	TG11CH	18"	4.8 lbs	6.6 lbs
			46 cm	2.2 kg	3.0 kg

Model	Item No.	Handle No.	Length	Head Weight	Weight
TG36	35425	TG11CH	18"	5.8 lbs	6 lbs
			46 cm	2.6 kg	2.7 kg



## Replacement Handles • Mangos de repuesto • Manches de remplacement

### Top Quality U.S. Hickory

U.S. Hickory de máxima calidad • Qualité supérieur U.S Hickory

 T11EHS  
New T11EHS orange safety grip handle. Specially formulated granulated handle coating provides extra grip for sure control of the steel bead breaking wedge

 T11EH

No. T11EH and T11EHS have New SureTight™  Old design safety heads to ensure the bead breaking wedge stays securely attached to the handle.  NEW SureTight™

Model	Item No.	For Hammer No.	Length	Weight
T11BH	35111	T11B	15" (38 cm)	.75 lbs (.3 kg)
T11HN	35113	T11R, T31, T33R	15" (38 cm)	.75 lbs (.2 kg)
T11CH	35119	T11C, T34, T35, T36	17" (43 cm)	.75 lbs (.3 kg)
T11DH	35127	T11D	17" (43 cm)	.75 lbs (.3 kg)
T11EH	35129	T11E®	30" (76 cm)	1.2 lbs (.5 kg)
NEW T11EHS	35131	T11E®	30" (76 cm)	1.2 lbs (.5 kg)

### Aluminum • Aluminio • Aluminium

Model	Item No.	For Hammer No.	Length	Weight
T11AH	35529	T11E®, TG11E	32" (81 cm)	4.3 lbs (2 kg)

### Polymer • Polímero • Polymère Patented

Model	Item No.	For Hammer No.	Length	Weight
T11KH	35230	T11K™	32" (81 cm)	2.3 lbs (1.0 kg)



### Fiberglass • Fibra de vidrio • Fibre de verre

 TG37H

Model	Item No.	For Hammer No.	Length	Weight
TG31H	35206	TG11R, TG31, TG33R	16" (41 cm)	1 lb (.5 kg)
TG11BH	35211	TG11B	16" (41 cm)	1.3 lbs (.6 kg)
TG11CH	35219	TG11C, TG34, TG35, TG36	18" (46 cm)	2.5 lbs (1.1 kg)
TG11DH	35227*	TG11D	18" (46 cm)	1.2 lbs (.5 kg)
TG11EH	35229*	TG11E	32" (81 cm)	2.3 lbs (1.0 kg)

\* Nulok adapter (others use epoxy).

## Replacement Rubber Heads

Cabezas de goma de repuesto

Tête de remplacement en caoutchouc



Model	Item No.	Description	For Hammer No.
T11RH	35104	Rubber Head	T11R, TG11R, T33R, TG31
T34RH	35105	Rubber Head	T34, TG34, T35, TG35, T36, TG36

## Epoxy Kits • Equipos de epoxi • Ensembles en époxy

Model	Item No.	Description	For Hammer No.
T12B	35201	Epoxy Kit	TG11B, TG11R, TG31, TG33R
T12D	35202	Epoxy Kit	TG34, TG35, TG36, TG37

**Tire Snake®****'Snake®' para llantas / 'Snake®' Outil à pneu Snake®**

Tire Snake mounting and demounting tools for use with center post tire changers. Included with T600 Tire Changer, designed for wheels from 4" to 12". Included with T601 Tire Changer, designed for wheels from 4" to 15", the longer length provides greater leverage. Patented.



Model	Item No.	Length	Stock	Weight
TS72	34672	22" (56 cm)	5/8" (2 cm)	2 lbs (.9 kg)
TS74	34674	28" (71 cm)	5/8" (2 cm)	2.5 lbs (1.1 kg)
TS42	34678	42" (102 cm)	3/4" (19 mm)	5.3 lbs (2.4 kg)

**Air Blast Bead Seater for Small Tires****Calzador a chorro de aire para llantas pequeñas****Air comprimé pour repos de talon de petits pneus**

For your small tire changing needs, Ken-Tool introduces a fast, easy and economical way to seat beads in one simple operation with the new Air Blast Bead Seater. This patent-pending air-blaster bead seater, seats the bead on most small tubeless tires with rims ranging from 4 to 12 inches. This is a one-man operation; just point, release, and watch this fast-acting bead seater do all the work.

Model	Item No.	Weight
31440	31440	5.6 lbs (2.5 kg)

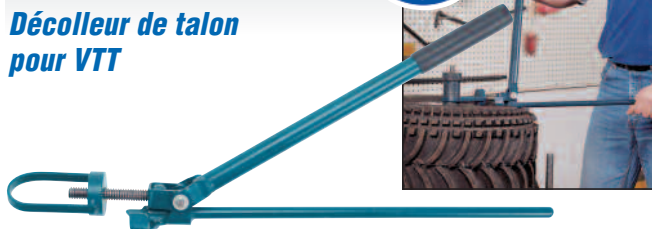
**ATV Bead Breaker****Desmontadora de llantas para vehículos todo terreno****Décolleur de talon pour VTT**

The ATV Bead Breaker is a manual solution that satisfies both manufacturers and tire changing technicians searching for a quick, safe, and affordable ATV bead breaker that really works. A rugged, yet lightweight tool that delivers the tremendous force necessary to overcome the resistance of a bead keeper. Constructed of heavy-duty steel, the ATV Bead Breaker works with any center post tire changing machine and adjusts to sizes of 6 to 12 inch ATV rims without the hassle of clevis pins. No hammers, wrenches, or additional tools are required. Very affordable! Patented.

Model	Item No.	Weight
38620	38620	7 lbs (3.2 kg)

**Manual Tire Changers****Cambiadores de llantas manuales****Démonteurs de pneus manuels****Floor Mount****Montaje de piso****Montage au sol**

Threadscrew has been milled to fit MTD wheels.

Mounts and demounts

a full range of tires on rim diameters from 4 to 15 inches. Tapered bearing guide positively centers straight shaft hubs of all diameters. A built-in, infinitely adjustable bead breaker works on rims up to 15" in diameter and 24" in width without disassembly. Includes a Ken-Tool exclusive, 28" Tire Snake® mount/demount tire tool. Patented.

Model	Item No.	Height	Weight
T601	38601	32" (81 cm)	31 lbs (14 kg)

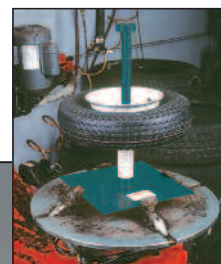
**Bench / Rim Clamp Mount****Montaje de banco/ abrazadera de llantas****Montage sur banc/crapaud**

Threadscrew has been milled to fit MTD wheels.

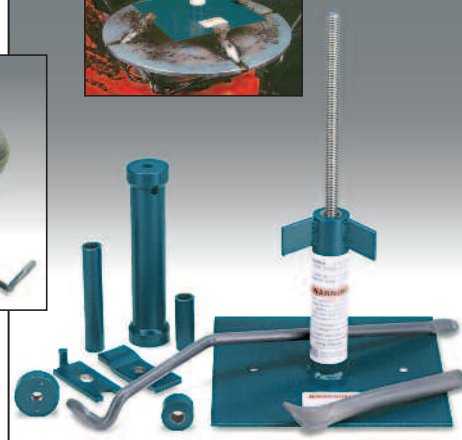

Mounts and demounts a full range of tires on rim diameters from 4 to 12 inches. Mounts easily to a bench or in any standard, four-position rim-clamp tire changer. A built-in, three fin centering device mounts standard lug-type rims with 2" and larger center hole. Square base prevents turning in the changer during use. Includes a Ken-Tool exclusive, 22" Tire Snake® mount/demount tire tool. Patented.

Model	Item No.	Height	Weight
T600	38600	16-1/2" (42 cm)	21.7 lbs (10 kg)

**For additional small tire tools see page 34**



## Professional Lug Nut Cover Remover

*Desmontador profesional de cubierta con tuercas*

*Dégageur professionnel d'écrous d'enjoliveurs de roues*

Special coating will not scratch or damage chrome, painted, or coated lug nut covers.

Model	Item No.	Weight
30606	30606	1.3 lbs (.6 kg)



## Tire Bead Seaters

*Calzador para llantas*

*Cordons de talon de pneus*

One-piece rubber tube for mounting hard-to-seat radial, bias-belted, or conventional truck tires. As tire is inflated, the lubricated bead seater forms a seal between the rim and tire, allowing the air pressure to force the beads into the rim flange. As proper pressure is reached, the bead seater slides out and over the rim. Use bead lubricant with bead seaters.



## Passenger / Light Truck

*Camión liviana/vehículo de pasajeros • Automobile/camion léger*

Model	Fits Rim Sizes	Weight
31446	14-15" (36 - 38 cm)	1.5 lbs (.7 kg)

## Truck • Camión • Camion

Model	Fits Rim Sizes	Weight
31437	16-1/2" to 17-1/2" (42 to 45 cm)	2 lbs (.9 kg)
31438	19-1/2" (50 cm)	2.3 lbs (1.0 kg)
31439	22-1/2" to 24-1/2" (57 to 62 cm)	2.3 lbs (1.0 kg)

## Pneumatic Bead Expanders

*Expansores neumáticos de llantas*

*Tubes d'extension de talon pneumatiques*

Expanders fit most bias ply passenger tires. A pliable neoprene rubber tube is encased in a tough, long-lasting nylon cover. Expanders slip easily over tire and withstand contact with oil, grease, solvents, and acids. Follow instructions included with tool. Use on bias ply, 14", 15", 70-series tires and larger. Expands bead by compressing tread. **T132** for belted bias ply tires, includes over-pressure release valve. **T133** for standard bias ply tires.



Model	Item No.	Min / Max Diameter	Tube Diameter	Weight
T132	31432	24 - 34" (61 - 86 cm)	2-1/4" (6 cm)	2.8 lbs (1.2 kg)
T133	31433	22 - 32" (60 - 81 cm)	3/4" (2 cm)	.75 lbs (.3 kg)

**Ken-Tool®**  
WHEREVER TIRES ARE CHANGED™

## Deep, Thin Wall Flip Socket

*Llave de tubo movable, de paredes finas y profundidad*

*Douille double tête profonde à paroi étroite*

1/2" square drive, black impact socket is deep and thin walled to reach areas conventional sockets won't. Flip socket provides two socket sizes which cover virtually all SAE automotive wheel lug sizes. **Imported.**

Model	Item No.	Socket Sizes	Drive	Weight
30156	30156	3/4", 13/16"	1/2" square	.4 lbs (.18 kg)
30158	30158	19 mm, 21 mm	1/2" square	.4 lbs (.18 kg)

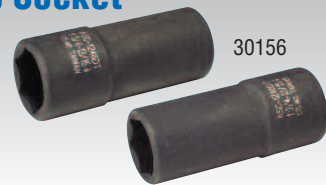

## Universal Emergency Wheel-Lock Remover

*Desmontador universal para anillos de seguridad de ruedas de emergencia*

*Dégageur de bloqueur de roue universel de secours*

Removes wheel locks when the key is lost or misplaced. Tapered socket fits over most car wheel locks. Use soft-faced hammer to drive onto wheel lock. Limited use.

Removes wheel locks when the key is lost or misplaced. Tapered socket fits over most car wheel locks. Use soft-faced hammer to drive onto wheel lock. Limited use.

Model	Item No.	Drive	Weight
30161	30161	1/2"	1 lb (.5 kg)

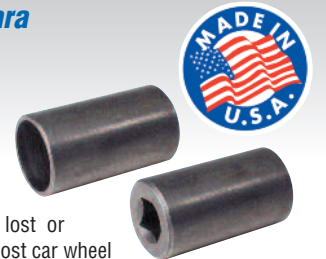

## Heavy-Duty Impact Sockets

*Llaves de tubo de impacto de alta resistencia*

*Douilles résistantes aux chocs*

## Special Purpose Impact Sockets Off-Road Budd, Square, SAE, and Metric

*Llaves de tubo de impacto especializados para todo terreno tipo Budd, cuadrados, de SAE y métricos*

*Douilles carrées, SAE, métrique ou pour roues à disques, spécialement conçues pour résister aux chocs*

Special 1-1/2" hex deep heavy-duty impact socket designed for outer cap nuts on Budd-style truck wheels. The 1-1/2" hex depth is limited to help prevent socket contact with the wheel. The socket is deep style to eliminate contact with the inner cap nut. **Imported.**

3/4" Drive		1" Drive		Weight
Model	Description	Model	Description	
30120	13/16" square	30149	13/16" square	1.4 lbs (.6 kg)



## Combination Budd Wheel - SAE and Metric

*Rueda de combinación tipo Budd- SAE y métrica*

*Deux en un pour roues à disques - SAE et métrique*

3/4" Drive		1" Drive		Weight
Model	Description	Model	Description	
30121	1-1/2" x 13/16" square	30150	1-1/2" x 13/16" square	3.1 lbs (1.4 kg)

## Deep Length Impact Sockets - SAE and Metric

*Llaves de tubo de impacto de longitud profunda- SAE y métrica*

*Douilles de profunde longueur - SAE et métrique*

6 point, 3/4" Drive		6 point, 1" Drive		Weight
Model	Description	Model	Description	
30356	33 mm deep	30366	33 mm deep	1.6 lbs (.7 kg)

KEN-TOOL®

## Tire Spreaders

*Separadores de llantas • Écarte-pneus*

### Tire Spreader with Lock Pin

*Separador de llanta con pasador de bloqueo*

*Écarte-pneu avec goupille de sécurité*



Imported.

Model	Item No.	Spread Capacity	Weight
T51	31551	4" - 6" (10-15 cm)	3.9 lbs (1.7 kg)

### Ratchet Action Truck Tire Spreader

*Separador de llantas para camiones*

*Ratchet Action*

*Écarte-pneu à rochet pour camions*

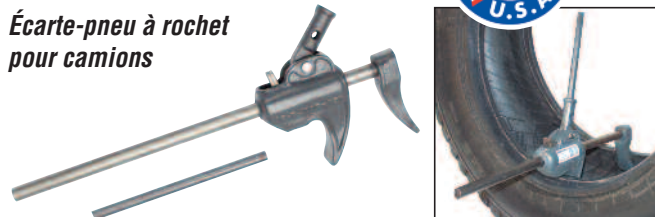

Model	Item No.	Spread Capacity	Weight
T54	31554	3-1/2" - 14" (9 - 36 cm)	7.3 lbs (3.3 kg)

## Wire Brush

*Cepillo de alambre*

*Brosse métallique*



Cleans rust from rims and wheels.

Model	Item No.	Length	Weight
T15	30515	14" (36 cm)	5 oz. (.2 kg)

## "Challenger" Wheel Balancer

*Balanceador de ruedas • Équilibrreuse de roues*

Accurate, easy-to-operate, self-leveling balancer with easy-to-read circular level accurately balances all wheels when using regular weights. Bubble type balancer is portable and may be used indoors or outdoors, even on a stone driveway. Convenient built-in weight storage space in the base of the balancer combines everything needed in 2 sq. ft. of floor space. All steel parts are plated to resist rust. Most passenger car wheels can be balanced directly on the balancer. Bubble will not freeze. Restriction: Minimum 1-1/2" diameter hub holes to maximum 4-1/2" hub holes. **Imported.**



Model	Item No.	Description	Size	Weight
X161	31361	Wheel Balancer	22"H x 12"W x 12"L	14 lbs (6.4 kg)
X-161-1	31361-01	Balance Head		5.3 lbs (2.4 kg)
X-161-99	31361-99	Bubble Device		.75 lbs (.3 kg)

## Aligning & Pry Bars

*Alineación y palancas*

*Leviers & barras d'alignement*



### Aligning Bars

*Barras de alineación • Barres d'alignement*

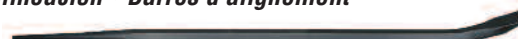

A forged, alloy steel, heat-treated bar that can be used for prying, aligning and positioning many heavier jobs in the shop. The finish is black oxide.

Model No.	Stock	Length	Weight
7025	5/8" (16 mm)	18" (45.7 cm)	1.4 lbs (.6 kg)
7026	3/4" (19 mm)	20" (50.8 cm)	2.3 lbs (1 kg)
7027	3/4" (19 mm)	24" (61 cm)	2.8 lbs (1.3 kg)
7028	7/8" (22 mm)	30" (76.2 cm)	5 lbs (2.3 kg)

### Close Quarters Bars

*Barras de cuartos cerrados • Barres à distance rapprochée*



These bars are made of forged, alloy steel, and heat-treated. Designed for use in tight spots, their balanced construction provides very powerful leverage. The finish is black oxide.

Model No.	Stock	Length	Weight
7030	3/8" (10 mm)	9" (22.9 cm)	.31 lbs (.14 kg)
7031	1/2" (13 mm)	16" (40.6 cm)	.89 lbs (.4 kg)
7032	5/8" (16 mm)	18" (45.7 cm)	1.5 lbs (.7 kg)

### Die Setter Bars

*Barras troqueladoras • Barres de monteur de matrices*



A practical and useful shop tool for the quick separation of punch and die holder. The bars are made of forged, alloy steel and heat-treated for strength. The finish is black oxide.

Model No.	Stock	Length	Weight
7035	5/8" (16 mm)	18" (45.7 cm)	1.7 lbs (.8 kg)
7037	3/4" (19 mm)	30" (76.2 cm)	4.2 lbs (1.9 kg)

## Professional Wheel Weight Tool

*Herramientas profesional para pesar ruedas*

*Outil professionnel pour masses d'équilibrage*

Clip-claw crowbar, punch designed handles, and heavy hammerhead provide years of use. **Imported.**



Model	Item No.	Weight
B230	35354	1 lb (.5 kg)

## Standard Wheel Weight Tool

*Herramientas estándar para pesar ruedas*

*Outil standard pour masses d'équilibrage*

This passenger car wheel weight tool is the industry standard. **Imported.**

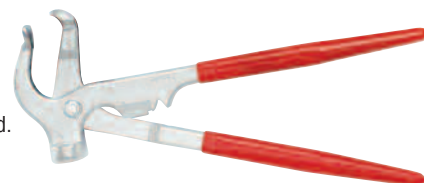

Model	Item No.	Weight
B232	35355	1 lb (.5 kg)

## Impact Separator Tool

*Impacto de la herramienta de separación • Outil impacteur*



Heavy-duty impact front end service tool. Hits harder and straighter than a hammer, but no more misses or glancing blows. Two easily interchangeable hardened steel forks. Use the T39B-1 fork to separate shock absorber links and tie rods; Use the T39B-2 fork on spindle support arms to remove ball joints without damaging other suspension parts. Services compact cars and light duty trucks too. Made in USA.

Includes impact separator tool with 2 forks:

35939-01 = T39B-1 Tie Rod Fork, Fork Opening: 5/8" (2 cm)

35939-02 = T39B-2 Ball Joint Fork, Fork Opening: 15/16" (2 cm)

Model	Item No.	Description	Length	Weight
T39B	35939	Impact Separator Tool w/2 forks		

## Front End Service Tools

*Herramientas para el mantenimiento delantero*

*Outils de service du train avant*



These tools are manufactured from a single piece of alloy steel, forged, and heat-treated for long life. Essential when replacing suspension parts. Striking ends have been enlarged to provide a bigger and safer striking surface. Painted finish for rust resistance. Ken-Tool offers a size and design for all your needs.

### Separator Tool • Herramienta separadora • Séparateur



Use to remove camber adjustment sleeves on Ford 4 x 2 and 4 x 4 pickups. Use as Pitman arm wedge on medium and heavy-duty trucks.

Model	Item No.	Length	Stock	Fork Opening	Weight
B36	32036	11" (28 cm)	7/8" (2 cm)	1-7/16" (4 cm)	1.9 lbs (.8 kg)

### Pitman Arm Wedge

*Cuña para la biela de mando de la dirección*

*Coin pour bielle pendante*



Removes Pitman arms on cars and light trucks.

Model	Item No.	Length	Stock	Fork Opening	Weight
B37	32037	11" (28 cm)	7/8" (2 cm)	1-1/8" (3 cm)	1.8 lbs (.8 kg)

### Shock Link and Tie Rod Separator

*Separador de la barra de acoplamiento y la unión del amortiguador*

*Fourche à barre d'accouplement et articulation d'amortisseur*



Use to separate shock absorber links and tie rods.

Model	Item No.	Length	Stock	Fork Opening	Weight
B39	32039	16" (41 cm)	7/8" (2 cm)	5/8" (2 cm)	2.1 lbs (.9 kg)

### Ball Joint Separator

*Separador de juntas de rótulas • Séparateur de joint à rotule*



Use on spindle support arms to remove ball joints without damaging other suspension parts. Services compact cars and light duty trucks.

Model	Item No.	Length	Stock	Fork Opening	Weight
B40	32040	16" (41 cm)	7/8" (2 cm)	15/16" (2 cm)	2.8 lbs (1.2 kg)

## MacPherson Strut Coil Spring Compressor Set

*Equipo compresor de resorte espiral de montante MacPherson*

*Groupe compresseur de ressort hélicoïdal à jambe de suspension*

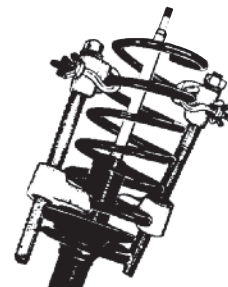

Compressor works on most MacPherson Strut assemblies and is for use with replacements. Use the compressor when replacing bent strut or strut tube and damaged spindles. Use it on or off the car. Acme threaded screw for durability. Do not use on General Motors "A", "C", "J", or "X" body cars.

Model	Item No.	Weight
39730	39730	7 lbs (3.1 kg)

## Professional 4-Way Valve Core Tool

*Herramienta profesional para núcleos de válvulas de 4 vías*

*Outil à valve professionnel 4 en 1 pour noyaux*



Handy 4-in-1 standard valve tool repairs cap threads, repairs core threads, has special easy-out feature for removing damaged cores, and screwdriver for removing standard cores. Black, heavy-duty hardened steel.



Model	Item No.	Weight
T16P	30215	1 oz (.04 kg)



Hard Cap® Safety Tools, the world's most comfortable automotive tools with new performance and safety technology.

### 1/2" Cold Chisel



*Cortafíos de 1/2 pulgadas • Ciseau plat de 1/2 po*

Model No.	Blade Width	Length	Weight
65104	1/2" (1.3 cm)	7" (17.8 cm)	.32 lbs (.14 kg)

### 3/4" Cold Chisel



*Cortafíos de 3/4 pulgadas • Ciseau plat de 3/4 po*

Model No.	Blade Width	Length	Weight
65106	3/4" (1.9 cm)	8" (20.3 cm)	.82 lbs (.37 kg)

### 7/8" Cold Chisel



*Cortafíos de 7/8 pulgadas • Ciseau plat de 7/8 po*

Model No.	Blade Width	Length	Weight
65107	7/8" (2.2 cm)	8.5" (21.5 cm)	.86 lbs (.39 kg)

### 1" Cold Chisel



*Cortafíos de 1 pulgada • Ciseau plat de 1 po*

Model No.	Blade Width	Length	Weight
65108	1" (2.5 cm)	8.5" (21.5 cm)	1.2 lbs (.54 kg)

### 1/8" Pin Punch



*Punzón de clavo de 1/8 pulgadas • Chasse-goupille 1/8 po*

Model No.	Punch Size	Length	Weight
66422	1/8" (.3 cm)	7" (17.8 cm)	.27 lbs (.12 kg)

### 5/32" Pin Punch



*Punzón de clavo de 5/32 pulgadas • Chasse-goupille 5/32 po*

Model No.	Punch Size	Length	Weight
66423	5/32" (.4 cm)	7" (17.8 cm)	.27 lbs (.12 kg)

### 3/16" Pin Punch



*Punzón de clavo de 3/16 pulgadas • Chasse-goupille 3/16 po*

Model No.	Punch Size	Length	Weight
66424	3/16" (.5 cm)	7" (17.8 cm)	.27 lbs (.12 kg)

### 1/4" Pin Punch



*Punzón de clavo de 1/4 pulgadas • Chasse-goupille 1/4 po*

Model No.	Punch Size	Length	Weight
66427	1/4" (.6 cm)	7" (17.8 cm)	.34 lbs (.15 kg)

### 3/16" Solid Punch



*Punzón sólido de 3/16 pulgadas • Poinçon plein de 3/16 po*

Model No.	Punch Size	Length	Weight
66401	3/16" (.5 cm)	7" (17.8 cm)	.29 lbs (.13 kg)

### 7/32" Center Punch



*Punzón para centrar de 7/32 pulgadas • Pointeau de 7/32 po*

Model No.	Punch Size	Length	Weight
66412	7/32" (.6 cm)	7" (17.8 cm)	.29 lbs (.13 kg)

### 1/4" Center Punch



*Punzón para centrar de 1/4 pulgadas • Pointeau de 1/4 po*

Model No.	Punch Size	Length	Weight
66414	1/4" (.6 cm)	7" (17.8 cm)	.37 lbs (.16 kg)

### 7/32" Prick Punch



*Punzón para marcar de 7/32 pulgadas  
Pointeau de traçage 7/32 po*

Model No.	Punch Size	Length	Weight
66435	1/4" (.6 cm)	7" (17.8)	.29 lbs (.13 kg)

### 3/16" Alignment Punch

*Punzón para alineación de 3/16 pulgadas  
Poinçon d'alignement de 3/16 po*



Model No.	Punch Size	Length	Weight
66440	3/16" (.5 cm)	9" (22.8 cm)	.34 lbs (.15 kg)

### 1/4" Alignment Punch

*Punzón para alineación de 1/4 pulgadas  
Poinçon d'alignement de 1/4 po*



Model No.	Punch Size	Length	Weight
66441	1/4" (.6 cm)	10" (25.4 cm)	.51 lbs (.23 kg)

### 5/16" Alignment Punch

*Punzón para alineación de 5/16 pulgadas  
Poinçon d'alignement de 5/16 po*



Model No.	Punch Size	Length	Weight
66442	5/16" (.8 cm)	11" (27.9 cm)	1 lb (.5 kg)

## Hard Cap® Chisel & Punch Sets

Hard Cap® Juegos de cinceles  
y punzones

Hard Cap® Ensembles ciseau et poinçon



### Four Piece Cold Chisel Set

Juego de cortafíos de cuatro piezas

Ensemble de 4 ciseaux plats



Set consists of: No. 65104 1/2" Cold Chisel  
No. 65106 3/4" Cold Chisel  
No. 65107 7/8" Cold Chisel  
No. 65108 1" Cold Chisel

Model No.	Description	Weight
66900	4 Piece Cold Chisel Set	3.1 lbs (1.4 kg)

### Four Piece Pin Punch Set

Juego de punzones de clavo de  
cuatro piezas

Ensemble de 4 chasse-goupilles



Set consists of: No. 66422 1/8" Pin Punch  
No. 66423 5/32" Pin Punch  
No. 66424 3/16" Pin Punch  
No. 66427 1/4" Pin Punch

Model No.	Description	Weight
66901	4 Piece Pin Punch Set	1 lb (.5 kg)

### Four Piece Punch Set

Juego de punzones de cuatro piezas

Ensemble de 4 poinçons



Set consists of: No. 66401 3/16" Solid Punch  
No. 66412 7/32" Center Punch  
No. 66414 7/8" Center Punch  
No. 66435 1" Prick Punch

Model No.	Description	Weight
66902	4 Piece Punch Set	1.1 lbs (.5 kg)

### Three Piece Alignment Set

Juego de alineación de tres piezas

Ensemble de 3 poinçons d'alignement



Set consists of: No. 66440 3/16" Alignment Punch  
No. 66441 1/4" Alignment Punch  
No. 66442 5/16" Alignment Punch

Model No.	Description	Weight
66907	3 Piece Alignment Set	1.8 lbs (.81 kg)



# Hard Cap®

## CHISELS AND PUNCHES

CINCELES Y PUNZONES DE TAPA DURA  
CISEAUX ET POINÇONS À BOUT RENFORCÉ

Hard Cap Safety Tools, the world's most comfortable automotive tools with new performance and safety technology.

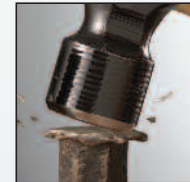

Eliminates flying fragments

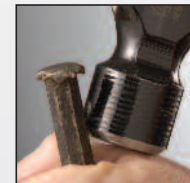

Reduces glancing blows



Eliminates mushrooming

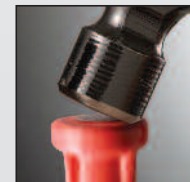

Impact disc efficiently transfers blow

- Unbreakable, tough reinforced polymer cap
- Comfortable grip reduces shock by up to 90%
- Noise level reduced by up to 80%
- Striking surface is 2 1/2 times larger
- Hammer kickback and wrist-elbow trauma minimized
- Oil resistant cushion grip reduces hot-cold feel
- Eliminates flying chips and mushrooming of chisel heads
- Four cap diameters to match hammer sizes
- The industry's sharpest and most accurate cutting edge
- Additional tools and sizes available
- Patented • Made in U.S.A.

## CROSS-REFERENCE BY PART NUMBER

ITEM NO.	MODEL NO.	PAGE NO.	ITEM NO.	MODEL NO.	PAGE NO.	ITEM NO.	MODEL NO.	PAGE NO.	ITEM NO.	MODEL NO.	PAGE NO.	ITEM NO.	MODEL NO.	PAGE NO.	ITEM NO.	MODEL NO.	PAGE NO.
7025		42	30206		12	31437		41	32433	T1921Z24	10,11	34547	TR44SW	30	35630		29
7026		42	30207		12	31438		41	32434	T2021Z24	10,11	34644	T45A-2000K	36	35633		29
7027		42	30208		12	31439		41	32435	T2122Z24	10,11	34645	T45A	36	35634		29
7028		42	30209		16	31440		40	32440	T1920Y24	10,11	34645C	T45AC	36	35635		29
7030		42	30211		12	31446		41	32441	T1922Y24	10,11	34647	T45HD	36	35637		29
7031		42	30212		12	31551	T51	42	32442	T2022Y24	10,11	34648	T48A	34	35638		29
7032		42	30213		12	31554	T54	42	32443	T1921Y24	10,11	34652	T52	32	35648		21
7035		42	30214		12	31564		31	32444	T2021Y24	10,11	34670	T100	32	35656	T56	28
7037		42	30215	T16P	43	31565	T65	31	32445	T2122Y24	10,11	34672	TS72	40	35657	T57	28
30000		16	30216		12	31566	T66	31	32450	T1920F24	10,11	34674	TS74	40	35659	T59	28
30101		15	30217		12	31567	T67	31	32451	T1922F24	10,11	34678	TS42	40	35661	T61	28
30102		15	30218		12	31568	T68	31	32452	T2022F24	10,11	34746	T46	35	35662	T62	28
30103		15	30219		12	31710		6,9,25,27,36	32453	T1921F24	10,11	34747	T46A	35	35663	T63	28
30106		14	30220		12	31711		9	32454	T2021F24	10,11	34748	T46B	35	35690	T90	28
30107		14	30221		12	31712		9	32455	T2122F24	10,11	34749	T46C	35	35695	T95	28
30108		14	30222		12	31713		9	32501	TR1	29	34846	T47	35	35696	T96	28
30109		14	30223		12	31714		9	32502	TR2	29	34847	T47A	35,36	35697	T95A	28
30110		15	30224		12	31810		4,6,25,27,36	32503	TR3	29	34848	T47B	35	35795	TM95	28
30111		15	30225		12	31820	T22R	10,11	32505	TR3A	29	34849	T47C	35	35805	D105A	8
30112		15	30226		12	31830	T1920Z18	10,11	32506	TR3X	29	34950	T950	7	35837		8
30113		15	30227		12	31831	T1922Z18	10,11	32508	TR98	29	35104	T11RH	39	35839		8
30114		15	30228		12	31832	T2022Z18	10,11	32509	TR9	29	35105	T34RH	39	35840		8
30115		15	30229		12	31833	T1921Z18	10,11	32512	TR2A	29	35110		38	35847	T147A	8
30116		14	30230		12	31834	T2021Z18	10,11	32519	TR99	29	35111	T11BH	39	35847S		8
30117		14	30231		12	31835	T2122Z18	10,11	32551	TRM1	29	35113	T11HN	39	35848		8
30118		14	30232		12	31840	T1920Y18	10,11	32552	TRM2	29	35119	T11CH	39	35924	T24B	33
30119		15	30233		12	31841	T1922Y18	10,11	32553	TRM3	29	35127	T11DH	39	35926	T26B	33
30120		41	30234		13	31842	T2022Y18	10,11	32556	TRM6	29	35129	T11EH	39	35934	T34B	5
30121		41	30235		13	31843	T1921Y18	10,11	32557	TRM7	29	35131	T11EHS	39	35935		5
30149		41	30236		12	31844	T2021Y18	10,11	32559	TRM6A	29	35201	T12B	39	35936	T36B	5
30150		41	30237		12	31845	T2122Y18	10,11	32610		29	35202	T12D	39	35939	T39B	43
30151		14	30238		12	31850	T1920X18	10,11	33020	T21A	10,11	35206	TG31H	39	35998	T98	33
30152		14	30239		12	31851	T1922X18	10,11	33021	T22A	10,11	35211	TG11BH	39	36001	T101	37
30153		14	30240		12	31852	T2022X18	10,11	33022	T19M	10,11	35219	TG11CH	39	36002	T102	37
30154		14	30241		12	31853	T1921X18	10,11	33023	T20M	10,11	35227	TG11DH	39	36003	T103	37
30156		41	30242		12	31854	T2021X18	10,11	33024	T21M	10,11	35229	TG11EH	39	36004	T104	37
30158		41	30243		12	31855	T2122X18	10,11	33025	T22M	10,11	35230	T11KH	39	36005	T105	37
30161		41	30244		12	32036	B36	43	33026	T22HD	10,11	35310	T32	38	36006	T106	37
30165		30	30245		15	32037	B37	43	33050	T1920A30	10,11	35311	T11B	39	36007	T101A	37
30170		13	30246		15	32039	B39	43	33051	T1922A30	10,11	35317	T33R	39	36015	T115	37
30171		13	30247		12	32040	B40	43	33052	T2022A30	10,11	35321	T34	39	36016		18
30174		13	30248		12	32101	T1X	10,11,35	33053	T1921A30	10,11	35323	T35	39	36017		18
30175		13	30249		12	32102	T2X	10,11,35	33054	T2021A30	10,11	35325	T36	39	36045		21
30176		13	30250		12	32106	T6A	34	33055	T2122A30	10,11	35327	T11D	38	36046		21
30179		13	30251		13	32109	T9A	10,11,34	33060	T1920M30	10,11	35329	T11E	38	36047		20
30180		13	30255		12	32110	T9C	10,11,34	33061	T1922M30	10,11	35331	TG331	38	37003	80H-3	38
30181		12	30256		12	32114		34	33062	T2022M30	10,11	35332	TG332	38	37004	80H-4	38
30182		12	30257		12	32115	T5	34	33063	T1921M30	10,11	35333	TG333	38	37103	85H-3	38
30183		12	30258		12	32116	T16A	10,11,34	33064	T2021M30	10,11	35334	TG334	38	37302	84H-2	38
30184		12	30270		14	32117	T16C	10,11,34	33065	T2122M30	10,11	35335	T335	38	37304	84H-4	38
30185		12	30271		14	32118	T8	34	33195		6	35336	T336	38	37308	84H-8	38
30186		12	30299		12	32119	T19A	10,11,35	33196		6,9	35337	TG337	38	37310	84H-10	38
30187		12	30356		41	32120	T20	10,11,35	33199		6	35354	B230	42	37312	84H-12	38
30188		12	30366		41	32121	T21R	10,11,35	33219	T19A	10,11,35	35355	B232	42	37316	84H-16	38
30189		12	30511	B111	8	32123	T23	33	33220	T20A	10,11,35	35364		29	37320	84H-20	38
30190		13	30515	T15	42	32125	T25	33	33223	T23A	33	35411	TG11B	39	38600	T600	40
30195		12	30605		14,30	32126	T26A	33	33224	T23B	33	35417	TG33R	39	38601	T601	40
30196		12	30606		41	32127	T27	33	33238	T38	10,11,35	35421	TG34	39	38620		40
30197		12	30609	TX9	31	32128	T27A	34	33239	T39	10,11,35	35423	TG35	39	39730		43
30198		12	30610	TX10	31	32129		19	33341	T41	32	35425	TG36	39	39805	T43A	34
30199		12	30612	TX12	31	32130		19	33342	T42	32	35427	TG11D	38	39806	T43C	35
30200		12	30618	TX200	31	32131		19	34121	T21F	10,11,35	35429	TG11E	38	39808	T44	35
30201		12	30619	TX241	31	32318	TR5	29	34122	T21HD	10,11,35	35440		4	39810	T43D	35
30202		12	30620	TX50	31	32420	T22F	10,11	34401	TR10	29	35460	T11K	38			
30203		12	31361	X161	42	32430	T1920Z24	10,11	34402	TR11	29	35529	T11AH	39			
30204		12	31432	T132	41	32431	T1922Z24	10,11	34543	TR43	30	35595	TC95	28			
30205		12	31433	T133	41	32432	T2022Z24	10,11	34545	TR44X	30	35620	T9520	28			

## CROSS-REFERENCE BY MODEL NUMBER

ITEM NO.	MODEL NO.	PAGE NO.	ITEM NO.	MODEL NO.	PAGE NO.	ITEM NO.	MODEL NO.	PAGE NO.	ITEM NO.	MODEL NO.	PAGE NO.	ITEM NO.	MODEL NO.	PAGE NO.
37003	80H-3	38	32128	T27A	34	35620	T9520	28	35795	TM95	28	<b>HARD CAP®</b>		
37004	80H-4	38	35310	T32	38	33050	T1920A30	10,11	32501	TR1	29	65104		44
37310	84H-10	38	35317	T33R	39	32450	T1920F24	10,11	32502	TR2	29	65106		44
37312	84H-12	38	35321	T34	39	33060	T1920M30	10,11	32512	TR2A	29	65107		44
37316	84H-16	38	35934	T34B	5	31850	T1920X18	10,11	32503	TR3	29	65108		44
37302	84H-2	38	35105	T34RH	39	31840	T1920Y18	10,11	32505	TR3A	29	66401		44
37320	84H-20	38	35323	T35	39	32440	T1920Y24	10,11	32506	TR3X	29	66412		44
37304	84H-4	38	35325	T36	39	31830	T1920Z18	10,11	32318	TR5	29	66414		44
37308	84H-8	38	35936	T36B	5	32430	T1920Z24	10,11	32509	TR9	29	66422		44
37103	85H-3	38	33238	T38	10,11,35	33053	T1921A30	10,11	34401	TR10	29	66423		44
30511	B111	8	33239	T39	10,11,35	32453	T1921F24	10,11	34402	TR11	29	66424		44
35354	B230	42	35939	T39B	43	33063	T1921M30	10,11	34543	TR43	30	66427		44
35355	B232	42	33341	T41	32	31853	T1921X18	10,11	34547	TR44SW	30	66435		44
32036	B36	43	33342	T42	32	31843	T1921Y18	10,11	34545	TR44X	30	66440		44
32037	B37	43	39805	T43A	34	32443	T1921Y24	10,11	32508	TR98	29	66441		44
32039	B39	43	39806	T43C	35	31833	T1921Z18	10,11	32519	TR99	29	66442		44
32040	B40	43	39810	T43D	35	32433	T1921Z24	10,11	32551	TRM1	29	66900		45
35805	D105A	8	39808	T44	35	33051	T1922A30	10,11	32552	TRM2	29	66901		45
32101	T1X	10,11,35	34645	T45A	36	32451	T1922F24	10,11	32553	TRM3	29	66902		45
32102	T2X	10,11,35	34644	T45A-2000K	36	33061	T1922M30	10,11	32556	TRM6	29	66907		45
32106	T6A	34	34645C	T45AC	36	31851	T1922X18	10,11	32559	TRM6A	29	<b>SERPENT™</b>		
32118	T8	34	34647	T45HD	36	31841	T1922Y18	10,11	32557	TRM7	29	35446		27
32109	T9A	10,11,34	34746	T46	35	32441	T1922Y24	10,11	34678	TS42	40	35447	T2005	26,27
32110	T9C	10,11,34	34747	T46A	35	31831	T1922Z18	10,11	34672	TS72	40	35448	T2006	26,27
35529	T11AH	39	34748	T46B	35	32431	T1922Z24	10,11	34674	TS74	40	35449	T2001	24,25
35311	T11B	39	34749	T46C	35	33054	T2021A30	10,11	30609	TX9	31	35450	T2002	24,25
35111	T11BH	39	34846	T47	35	32454	T2021F24	10,11	30610	TX10	31	35453		25
35119	T11CH	39	34847	T47A	35,36	33064	T2021M30	10,11	30612	TX12	31	<b>PRO SUPER HUB-SHARK®</b>		
35327	T11D	38	34848	T47B	35	31854	T2021X18	10,11	30620	TX50	31	7326		17
35127	T11DH	39	34849	T47C	35	31844	T2021Y18	10,11	30618	TX200	31	7326U		17
35329	T11E	38	34648	T48A	34	32444	T2021Y24	10,11	30619	TX241	31	<b>VICES &amp; CLAMPS</b>		
35129	T11EH	39	32115	T5	34	31834	T2021Z18	10,11	31361	X161	42	39604		23
35131	T11EHS	39	31551	T51	42	32434	T2021Z24	10,11				39606		23
35113	T11HN	39	34652	T52	32	33052	T2022A30	10,11				39608		23
35460	T11K	38	31554	T54	42	32452	T2022F24	10,11				64055		22,23
35230	T11KH	39	35656	T56	28	33062	T2022M30	10,11				64065		22,23
35104	T11RH	39	35657	T57	28	31852	T2022X18	10,11				64650		22,23
35201	T12B	39	35659	T59	28	31842	T2022Y18	10,11				64800		22,23
35202	T12D	39	35661	T61	28	32442	T2022Y24	10,11						
30515	T15	42	35662	T62	28	31832	T2022Z18	10,11						
32116	T16A	10,11,34	35663	T63	28	32432	T2022Z24	10,11						
32117	T16C	10,11,34	31565	T65	31	33055	T2122A30	10,11						
30215	T16P	43	31566	T66	31	32455	T2122F24	10,11						
32119	T19	10,11,35	31567	T67	31	33065	T2122M30	10,11						
33219	T19A	10,11,35	31568	T68	31	31855	T2122X18	10,11						
33022	T19M	10,11	35690	T90	28	31845	T2122Y18	10,11						
32120	T20	10,11,35	35695	T95	28	32445	T2122Y24	10,11						
33220	T20A	10,11,35	35697	T95A	28	31835	T2122Z18	10,11						
33023	T20M	10,11	35696	T96	28	32435	T2122Z24	10,11						
33020	T21A	10,11	35998	T98	33	35595	TC95	28						
34121	T21F	10,11,35	34670	T100	32	35411	TG11B	39						
34122	T21HD	10,11,35	36001	T101	37	35211	TG11BH	39						
33024	T21M	10,11	36007	T101A	37	35219	TG11CH	39						
32121	T21R	10,11,35	36002	T102	37	35427	TG11D	38						
33021	T22A	10,11	36003	T103	37	35227	TG11DH	39						
32420	T22F	10,11	36004	T104	37	35429	TG11E	38						
33026	T22HD	10,11	36005	T105	37	35229	TG11EH	39						
33025	T22M	10,11	36006	T106	37	35206	TG31H	39						
31820	T22R	10,11	36015	T115	37	35417	TG33R	39						
32123	T23	33	31432	T132	41	35421	TG34	39						
33223	T23A	33	31433	T133	41	35423	TG35	39						
33224	T23B	33	35847	T147A	8	35425	TG36	39						
35924	T24B	33	35335	T335	38	35331	TG331	38						
32125	T25	33	35336	T336	38	35332	TG332	38						
32126	T26A	33	38600	T600	40	35333	TG333	38						
35926	T26B	33	38601	T601	40	35334	TG334	38						
32127	T27	33	34950	T950	7	35337	TG337	38						



Throughout this catalog watch for YouTube symbols that indicate one or more videos are available for the product you are reviewing. Then go to [www.youtube.com/kentoolvideomedia](http://www.youtube.com/kentoolvideomedia) to find a selection of videos for our products. You can also scan the barcode with your Smartphone to get a link to our YouTube videos or details on how to Contact Us at Ken-Tool.

Distributed By:



768 E. North Street, P.O. Box 9320  
Akron, Ohio 44305

Phone: 330-535-7177 • Fax: 330-535-1345

E-mail: [sales@kentool.com](mailto:sales@kentool.com)

[www.kentool.com](http://www.kentool.com)